

شرکت شمیم صنعت  
نمایندگی فروش برند **NEO**

NE900 SERIES  
HIGH-PERFORMANCE AC DRIVE  
**User Manual**



شماره های تماس:

021-88530942      021-88174830

021-88752365      021-88731721

---

## Preface

NE900 series is the new generation products to meet general purpose and special technical demand. The new designed sensorless vector control performance of NE900 inverter have improved the reliability at low speed, the overload capacity at low frequency and high control precision at open loop tension control mode. Its function of anti-trip and strong adaptability to worse grid, temperature, humidity and dust make it meet the high-performance requirement of the customer application.

NE900 series inverters built-in RS485 interface which can use software upload, download and monitoring the parameter of inverter. Built-in PID, 16 multi-speed, traverse control can realize various complicate high-accuracy drives and widely apply in Textile, paper industry, machine tool, package, printing, pump and fan.

This manual provides installation and configuration, parameters setting, fault diagnoses and daily maintenance and relative precautions to customers. Please read this manual carefully before the installation to ensure a proper installation and operation and high performance of NE900 series inverters.



**DANGER:** indicates the situation in which the failure to follow operating requirements may result in fire or serious personal injury or even death.



**CAUTION:** indicates the situation in which the failure to follow operating requirements may cause moderate or slight injury and damage to equipment.

---

# Contents

<b>Preface</b> .....	1
<b>Chapter 1 Precautions</b> .....	<b>5</b>
1.1 Safety Precautions.....	5
1.2 Precautions for use.....	8
1.3 Disposal considerations .....	10
<b>Chapter 2 Product Introduction</b> .....	<b>11</b>
2.1 Naming rules .....	11
2.2 Nameplate information.....	11
2.3 Series and Models .....	12
2.4 Specifications .....	13
2.5 Products appearance.....	16
2.6 Installation size .....	17
2.7 Optional Parts.....	21
<b>Chapter 3 Installation and Wire Connection</b> .....	<b>23</b>
3.1 Mechanical installation.....	23
3.2 Standard wiring.....	24
3.3 EMC Installation Instruction .....	35
<b>Chapter 4 Operation and operation examples</b> .....	<b>39</b>
4.1 Initial power-up .....	39
4.2 Inverter operation .....	40
4.3 Keypad introduce .....	42
4.4 Display status .....	45
4.5 Keypad operation .....	48
<b>Chapter 5 Function Code Table</b> .....	<b>51</b>

---

5.1 Property description .....	51
5.2 Function code table.....	51
<b>Chapter 6 Detailed Function Parameter Description.....</b>	<b>93</b>
Group P0 Standard Function Parameter .....	93
Group P1 Start/Stop Parameter .....	103
Group P2 Auxiliary Functions .....	108
Group P3 Input Terminals .....	120
Group P4 Output Terminals.....	133
Group P5 V/F curve parameters .....	141
Group P6 PID Function parameters .....	146
Group P7 Operation Panel and Display .....	156
Group P8 Motor Parameters .....	159
Group P9 Vector Control Parameters .....	162
Group PA Fault and Protection .....	168
Group Pb Multi-Reference and Simple PLC Function .....	177
Group PC Communication Parameter .....	181
Group Pd Function Code Management .....	181
Group PE Swing Frequency, Fixed Length and Count.....	182
Group PF AI/AO Correction and AI Curve Setting .....	186
Group E0 Ser function code parameter .....	188
Group E6 Motor parameters.....	189
Group E9 Protection function parameter .....	189
2nd, 3rd, and 4th motor parameters (E3, E4, E5 groups).....	192
Monitoring parameter group-operation parameter monitoring (group b0) ) .....	192
<b>Chapter 7 Fault Diagnosis and Processing .....</b>	<b>193</b>
7.1 Failure Phenomena and Countermeasures .....	193
7.2 Fault Record Query.....	197





---



7.3 Fault Reset .....	197
<b>Chapter 8 Maintenance and Maintenance e.....</b>	<b>199</b>
8.1 Daily maintenance and Maintenance .....	199
8.2 Periodic Preservation and Maintenance.....	199
8.3 Warranty Description .....	200
<b>Chapter 9 Serial Port RS485 Communication Protocol .....</b>	<b>202</b>
9.1 Communication Overview.....	202
9.2 Communication Protocol Description.....	202
9.3 Communication Protocol .....	204







---

# Chapter 1 Precautions

## 1.1 Safety Precautions

The use phase	Safety class	Precaution
Before Installation	 Danger	<ul style="list-style-type: none"><li>◆ Do not install the product if the package is with water, or component is missing or broken;</li><li>◆ Do not install the product if the label on the package is not identical to that on the inverter.</li></ul>
	 Caution	<ul style="list-style-type: none"><li>◆ Be careful of carrying or transportation. Risk of devices damage.</li><li>◆ Do not use damaged product or the inverters missing component. Risk of injury.</li><li>◆ Do not touch the parts of control system with bare hands. Risk of ESD hazard.</li></ul>
Installation	 Danger	<ul style="list-style-type: none"><li>◆ Installation base shall be metal or other non-flammable material. Risk of fire.</li><li>◆ Do not install inverter in an environment containing explosive gases, otherwise there is danger of explosion.</li><li>◆ Do not unscrew the fixing bolts, especially the bolts with red mark.</li></ul>
	 Caution	<ul style="list-style-type: none"><li>◆ Do not leave cable strips or screws in the inverter. Risk of inverter damage.</li><li>◆ Install the product at the place with less vibration and no direct sunlight.</li><li>◆ Consider the installation space for cooling purpose when two or more inverters are placed in the same cabinet.</li></ul>

The use phase	Safety class	Precaution
Wiring	 Danger	<ul style="list-style-type: none"> <li>◆ Wiring must be performed by authorized and qualified personnel. Risk of danger.</li> <li>◆ Circuit-breaker should be installed between inverter and the mains. Risk of fire.</li> <li>◆ Make sure the input power supply has been completely disconnected before wiring. Failure to comply may result in personnel injury and/or equipment damage.</li> <li>◆ Since overall leakage current of this equipment may be bigger than 3.5mA, for safety's sake, this equipment and its associated motor must be well grounded so as to avoid risk of electric shock.</li> <li>◆ Never connect the power cables to the output terminals (U, V, W) of the AC drive. Pay attention to the marks of the wiring terminals and ensure correct wiring. Failure to comply will result in damage to the AC drive.</li> <li>◆ Install braking resistors at terminals (P+) and (P- or PB) only. Failure to comply may result in equipment damage.</li> </ul>
	 Caution	<ul style="list-style-type: none"> <li>◆ Since all adjustable frequency AC drives from our company has been subjected to hi-pot test before delivery, users are prohibited from implementing such a test on this equipment. Failure to comply may result in equipment damage.</li> <li>◆ Signal wires should to the best of the possibility be away from main power lines. If this cannot be ensured, vertical cross-arrangement shall be implemented, otherwise interference noise to control signal may occur.</li> <li>◆ If motor cables are longer than 100m, it is</li> </ul>

The use phase	Safety class	Precaution
		recommended output AC reactor be used. Failure to comply may result in faults.
Before Power-on	 Danger	<ul style="list-style-type: none"> <li>◆ Inverter shall be power-on only after the front cover is assembled. Risk of electrical hazard.</li> </ul>
	 Caution	<ul style="list-style-type: none"> <li>◆ Verify that the input voltage is identical to the rated voltage of product, correct wiring of input terminals R, S, T and output terminals U, V, and W, wiring of inverter and its peripheral circuits, and all wires should be in good connection. Risk of inverter damage.</li> </ul>
After Power-on	 Danger	<ul style="list-style-type: none"> <li>◆ Do not open the cover after power. Risk of electrical hazard.</li> <li>◆ Do not touches any input/output terminals of inverter with bare hands. Risk of electrical hazard.</li> </ul>
	 Caution	<ul style="list-style-type: none"> <li>◆ If auto tuning is required, be careful of personal injury when motor is running. Risk of accident.</li> <li>◆ Do not change the defaults of parameters. Risk of devices damage.</li> </ul>
During Operation	 Danger	<ul style="list-style-type: none"> <li>◆ Non-professionals shall not detect signals during operation. Risk of personal injury or device damage.</li> <li>◆ Do not touch the fan or the discharging resistor to check the temperature. Failure to comply will result in personal burnt.</li> </ul>
	 Caution	<ul style="list-style-type: none"> <li>◆ Prevent any foreign items from being left in the devices during operation. Risk of device damage.</li> <li>◆ Do not control start/stop of inverter by ON/OFF of contactor. Risk of device damage.</li> </ul>



The use phase	Safety class	Precaution
Maintenance	 Danger	<ul style="list-style-type: none"> <li>◆ Maintenance and inspection can only be performed by professionals. Risk of personal injury.</li> <li>◆ Maintain and inspect devices after power is off. Risk of electric hazard.</li> <li>◆ Repair or maintain the AC drive only ten minutes after the AC drive is powered off. This allows for the residual voltage in the capacitor to discharge to a safe value. Failure to comply will result in personal injury.</li> <li>◆ All pluggable components can be inserted or pulled out only when power has been turned off.</li> <li>◆ Set and check the parameters again after the AC drive is replaced.</li> </ul>

## 1.2 Precautions for use

When using the NE900 series inverter, please pay attention to the following points:

### 1.2.1 Constant torque and low speed operation

When the inverter is running with a normal motor for a long period of low speed, the heat dissipation effect will be deteriorated, which will affect the life of the motor. If you need low-speed constant torque for long-term operation, you must use a dedicated inverter motor.

### 1.2.2 Confirmation of motor insulation

When applying the NE900 series inverter, please confirm the insulation of the motor before using the motor to prevent damage to the equipment. In addition, please check the insulation of the motor regularly when the environment of the motor is bad, to ensure the safe operation of the system.

### 1.2.3 Negative torque load

For situations such as lifting the load, there is often a negative torque, and the inverter will trip if an overcurrent or overvoltage fault occurs. In this case, the optional braking resistor should be considered.

### 1.2.4 Mechanical resonance point of the load device

The inverter may encounter the mechanical resonance point of the load device within a certain range of output frequency, and must be avoided by setting the jump frequency.

### 1.2.5 Capacitance or varistor for improving power factor

Since the output voltage of the inverter is pulse wave type, if the output side is equipped with a capacitor with improved power factor or a varistor for lightning protection, it will cause the inverter to trip or damage the device. Be sure to remove it, and it is recommended not to be on the output side. Add switching devices such as air switches and contactors, as shown in Figure 1-1. (If the output of the inverter must be zero when the output side switch device is activated)

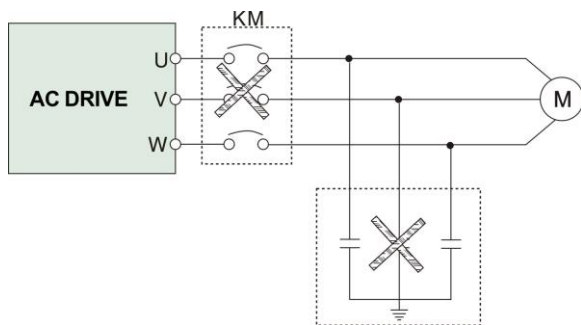

Figure 1-1 Disabling the capacitor at the output of the inverter

### 1.2.6 Derate at Basic frequency setting

When the fundamental frequency setting is lower than the rated frequency, please pay attention to the derating of the motor to avoid overheating of the motor.

### 1.2.7 Operating at frequencies above 50Hz

If it is operated above 50 Hz, in addition to considering the vibration and noise of the motor, it is necessary to ensure the speed range of the motor bearings and mechanical devices.

### 1.2.8 Electronic thermal protection value of the motor

When the adapter motor is selected, the inverter can thermally protect the motor. If the motor does not match the rated capacity of the inverter, be sure to adjust the protection value or take other protective measures to ensure the safe operation of the motor.

### 1.2.9 Altitude and derating

In areas where the altitude is more than 1000 meters, the heat dissipation effect of the inverter is deteriorated due to the thin air, and it is necessary to derate the use. Figure 1-2 shows the relationship between the rated current of the inverter and the altitude.

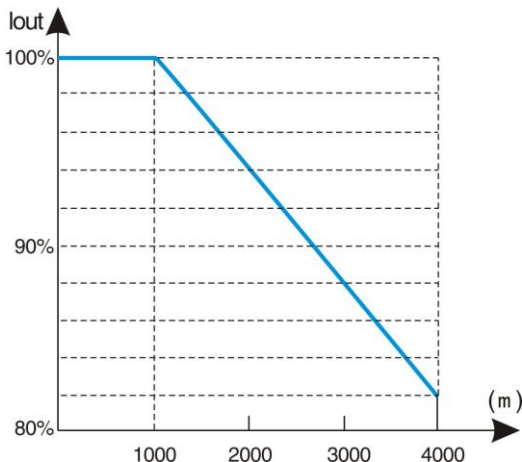

Figure 1-2 Inverter rated output current and altitude derating diagram

### 1.2.10 About the degree of protection

The protection level IP20 of the NE900 inverter refers to the degree of protection achieved when the status display unit or keyboard is selected.

### 1.3 Disposal considerations

When scrapping the inverter, please note:

The electrolytic capacitor of the main circuit and the electrolytic capacitor on the printed circuit board may explode when incinerated. Poisonous gas is generated when plastic parts are incinerated body. Please treat as industrial waste.

## Chapter 2 Product Introduction

### 2.1 Naming rules

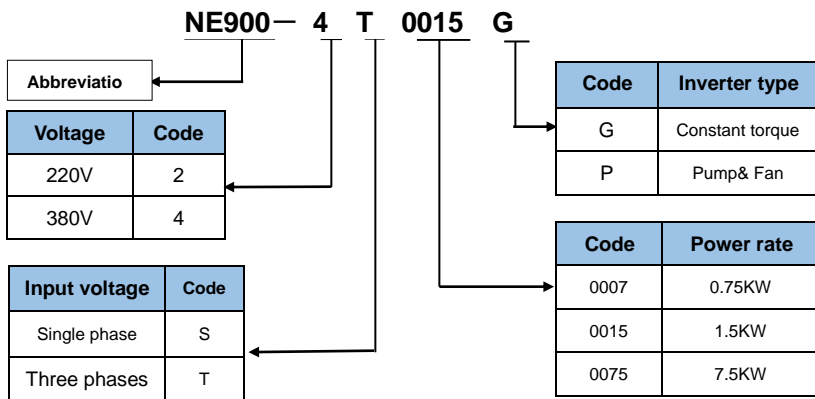

Fig 2-1. Models description

### 2.1 Nameplate information

Below the right side panel of the inverter, a nameplate indicating the inverter model and rating is attached. The meanings are as follows:

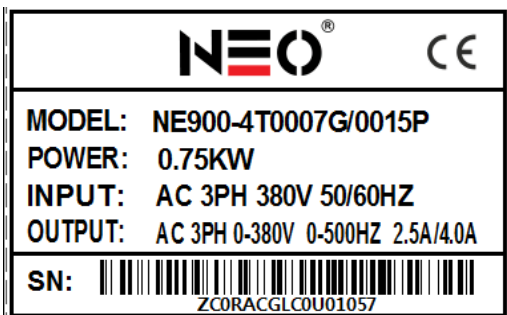

Fig 2-2. Name Designation Rules

## 2.3 Series and Models

Voltage level	Model		Rated capacity (KVA)	Rated output Current (A)	Applicable Motor (KW)
	G Type	P Type			
380V Three phase	NE900-4T0007G	NE900-4T0015P	1.5	2.5	0.75
	NE900-4T0015G	NE900-4T0022P	2.5	4.0	1.5
	NE900-4T0022G	NE900-4T0022P	3.0	6.0	2.2
	NE900-4T0037G	NE900-4T0037P	5.9	9.6	3.7
	NE900-4T0055G	NE900-4T0055P	8.5	14.0	5.5
	NE900-4T0075G	NE900-4T0075P	11	17.0	7.5
	NE900-4T0110G	NE900-4T0110P	17	25	11
	NE900-4T0150G	NE900-4T0150P	21.7	32	15
	NE900-4T0185G	NE900-4T0185P	25.7	39	18.5
	NE900-4T0220G	NE900-4T0220P	29.6	45	22
	NE900-4T0300G	NE900-4T0300P	39.5	60	30
	NE900-4T0370G	NE900-4T0370P	49.4	75	37
	NE900-4T0450G	NE900-4T0450P	60	91	45
	NE900-4T0550G	NE900-4T0550P	73.7	112	55
	NE900-4T0750G	NE900-4T0750P	99	150	75
	NE900-4T0900G	NE900-4T0900P	116	176	90
	NE900-4T1100G	NE900-4T1100P	138	210	110
	NE900-4T1320G	NE900-4T1320P	167	253	132
	NE900-4T1600G	NE900-4T1600P	200	304	160
	NE900-4T1850G	NE900-4T1850P	234	355	187
	NE900-4T2000G	NE900-4T2000P	248	377	200
	NE900-4T2200G	NE900-4T2200P	280	426	220
	NE900-4T2500G	NE900-4T2500P	318	474	250
	NE900-4T2800G	NE900-4T2800P	342	520	280
NE900-4T3150G	NE900-4T3150P	390	600	315	
NE900-4T3500G	NE900-4T3500P	435	660	350	
NE900-4T4000G	NE900-4T4000P	493	750	400	

Voltage level	Model		Rated capacity (KVA)	Rated output Current (A)	Applicable Motor (KW)
	G Type	P Type			
	NE900-4T4500G	NE900-4T4500P	560	850	450
	NE900-4T5000G	NE900-4T5600P	625	860	500
	NE900-4T5600G	NE900-4T6300P	691	990	560
	NE900-4T6300G	NE900-4T7100P	770	1100	630

## 2.4 Specifications

Items		Specifications
Input	Rated Voltage	Three phase 380V / 415V / 440V/460V; 50Hz/60Hz
	Range	Voltage: $\pm 20\%$ voltage unbalance rate: $< 3\%$ ; frequency: $\pm 5\%$
Output	Rated voltage	0~380V / 415V / 440V/460V
	Frequency range	0Hz~3000Hz
	Frequency resolution	0.01Hz
	Overload ability	150% rated current for 1 minute, 180% rated current for 3 seconds
Control function	Torque control accuracy	$\pm 5\%$ (FVC)
	Control mode	V/F, Sensorless vector control (SVC), Speed Sensor vector control (FVC)
	Frequency accuracy	Digital setting: The highest frequency $\times \pm 0.01\%$ Analog setting: The highest frequency $\times \pm 0.2\%$
	Frequency resolution	Digital setting: 0.01Hz; Analog setting: The highest frequency $\times 0.1\%$
	Start frequency	0.40Hz~20.00Hz
	Torque boost	Auto torque boost, manual torque boost 0.1%~30.0%
	V/F curve	Five ways: constant torque V/F curve, 1 kind of user defined V/F curve, 3 kinds of down torque curve (2.0/1.7/1.2 times the power)

Items		Specifications
	Acc./Dec. curve	Two ways: linear Acc./Dec., S-curve Acc./Dec.;7 kinds of Acc./Dec. time, Time unit(minute/second) optional, max. time: 6000 minutes.
	DC braking	DC Braking Frequency: 000Hz~ Max Frequency Braking Time: 0.0s~36.0s Braking Action Current Value: 0.0%~100.0%
	Energy consuming braking	Below 22KW drive built-in energy consuming braking unit, 30-37KW built-in braking unit optional, external braking resistor is optional.
	Jog running	Jog frequency range:0.1Hz~50.00Hz, JOG Acc./Dec. time: 0.1~60.0s
	Build-in Double PID	Easily constitute a close loop control system
	Multi-stage speed running	Max 16 multi-stage speed running via build-in PLC or control terminals
	Textile swing frequency	Swing frequency available with preset and central frequency adjustable
	Auto voltage regulation	Keep a stable voltage automatically when the grid voltage transients
	Auto energy saving running	Saving energy by auto optimizing V/F curve according to the load
	Auto current limiting	Auto current limiting to prevent frequent over current fault trip
	Multi pumps control	With water supply card, the function can implement multi pumps constant pressure water supply
	Communication	4 field bus: Modbus, Profibus, CANlink, CANopen
	Running command channel	Control panel: control terminal :serial port :3 channels switchable

Items		Specifications
Running function	Frequency setting channel	Control panel potentiometer setting: ▲、▼ control panel keys setting; Function code setting: Serial port setting; Terminal up/down setting: Input Analog voltage setting: Input Analog current setting: Input pulse setting; Combination ways setting; Above ways are switchable.
	Input channel	8 digital input terminals, 1 of which supports up to 100KHZ high speed pulse input 2 analog input terminals, 1 support 0~10V voltage input 1 support 0~10V voltage input or 0~20mA current input
	Output channel	1 high-speed pulse output terminal (optional open collector type), supporting square wave signal output of 0~100Khz 1 digital output terminal 2 relay output terminals ( $\geq 5.5\text{kw}$ ), one relay below 5.5kw 2 analog output terminals, support 0~20mA current output or 0~10V voltage output ( $\geq 5.5\text{kw}$ 2 terminals) $< 5.5\text{kw}$ 1 terminal
Control panel	LED digital display	Display setting frequency, output voltage, output current, etc.
	External meter display	Display output frequency, output current, output voltage, etc.
	Key lock	All the keys can be locked
	Parameter copy	Function code parameters can be copied between inverters when use remote control panel
Protection function		Over current tprotection: overvoltageprotection: undervoltageprotection: overheating protection: overload protection, etc. Input phase loss protection ( model>2.2kw)
Optional parts		Braking unit: remote control panel: cable: panel mounting feet, etc.
Environment	Environment	Indoors, free from direct sunlight, dust, corrosive gas, oil mist, steam, water dropper salt, etc
	Altitude	Lower than 1000m (derating is necessary above 1000m)
	Ambient temperature	-10℃~+40℃
	Humidity	<90%RH, no condensation
	Vibration	Lower than 5.9m/s (0.6g)



Items		Specifications
	Storage temperature	-20℃~+60℃
Structure	Protection level	IP20 (In the selection of state display unit or the keyboard state)
	Cooling	Forced air cooling
Installation		Wall mounted; Floor mounted

## 2.5 Products appearance

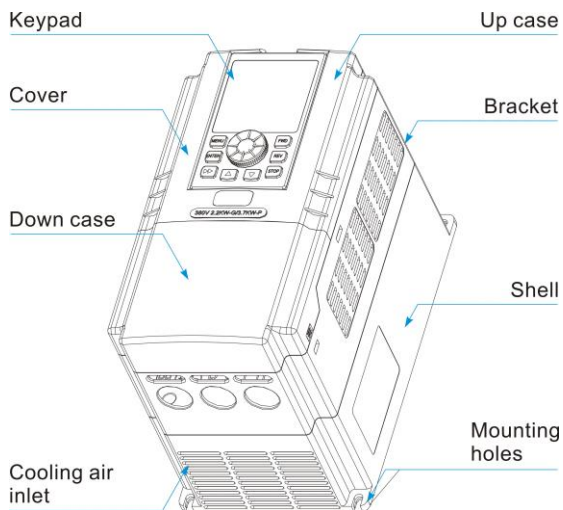

Fig 2-3 parts of Inverter

## 2.6 Installation size

### 2.6.1 0.75~22KW (Plastic shell)

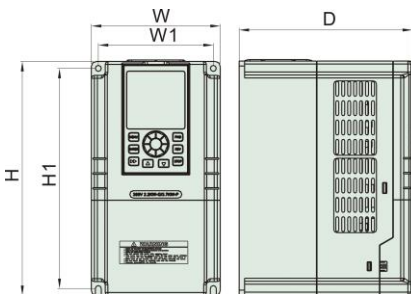

Fig 2-4

Inverter Model		W1 (mm)	W (mm)	H1 (mm)	H (mm)	D (mm)	Mount hole
G Type	P Type						
NE900 series/Input voltage: 220V single phase							
NE900-2S0004G		72.5	85	149.5	142	110	Φ5
NE900-2S0007G							
NE900-2S0015G							
NE900-2S0022G							
NE900 series/Input voltage: 380V three-phase							
NE900-4T0007G	NE900-4T0015P	90	104	176	190	150	Φ5
NE900-4T0015G	NE900-4T0022P						
NE900-4T0022G	NE900-4T0037P	116	130	222	236	176	Φ6
NE900-4T0037G	NE900-4T0055P						
NE900-4T0055G	NE900-4T0075P	155	172	256	272	182	Φ7
NE900-4T0075G	NE900-4T0110P						
NE900-4T0110G	NE900-4T0150P	188	316	316	330	200	Φ7
NE900-4T0150G	NE900-4T0185P						
NE900-4T0185G	NE900-4T0220P						
NE900-4T0220G	NE900-4T0300P						

## 2.6.2 11~160KW (Iron shell)

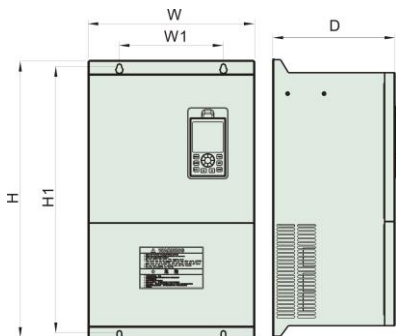

Fig 2-5

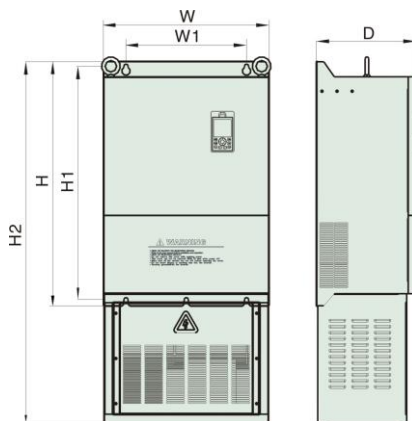

Fig 2-6 (Add base)

Inverter Model		W1 (mm)	W (mm)	H1 (mm)	H (mm)	D (mm)	Mount hole
G Type	P Type						
NE900 series/Input voltage: 380V three-phase							
NE900-4T0110G	NE900-4T0150P	170	248	346	360	210	Φ7
NE900-4T0150G	NE900-4T0185P						
NE900-4T0185G	NE900-4T0220P	200	260	427	445	230	Φ9
NE900-4T0220G	NE900-4T0300P						
NE900-4T0300G	NE900-4T0370P	200	320	511	530	325	Φ9
NE900-4T0370G	NE900-4T0450P						
NE900-4T0450G	NE900-4T0550P	250	310	530	555	260	Φ12
NE900-4T0550G	NE900-4T0750P						
NE900-4T0750G	NE900-4T0900P	280	400	619.5	650	300	Φ14
NE900-4T0900G	NE900-4T1100P						
NE900-4T1100G	NE900-4T1320P						
NE900-4T1320 G	NE900-4T1600P	280	450	756	790	300	Φ14
NE900-4T1600 G	NE900-4T1850P						

### 2.6.3 185~250KW (Iron shell)

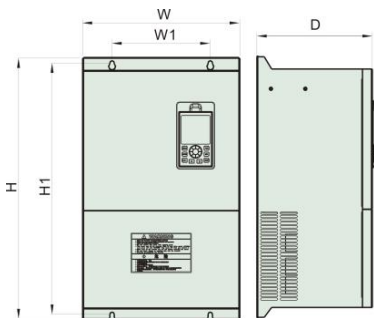

Fig 2-7

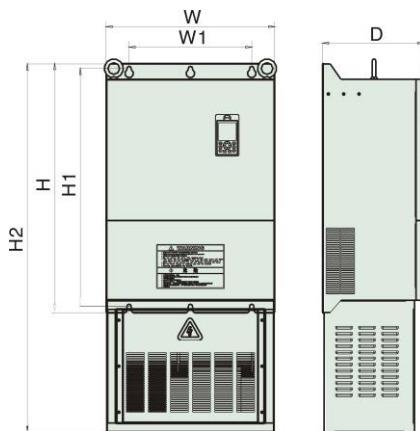

Fig 2-8 (Add base)

Inverter Model		W1 (mm)	W (mm)	H2 (mm)	H1 (mm)	H (mm)	D (mm)	Mount hole
G Type	P Type							
NE900 series/Input voltage: 380V three-phase								
NE900-4T1850G	NE900-4T2000P	400	550	1200	775	810	330	Φ14
NE900-4T2000G	NE900-4T2200P							
NE900-4T2200G	NE900-4T2500P	480	640	1270	775	810	350	Φ12
NE900-4T2500G	NE900-4T2800P							

### 2.6.4 280~400KW (Floor mouthing)

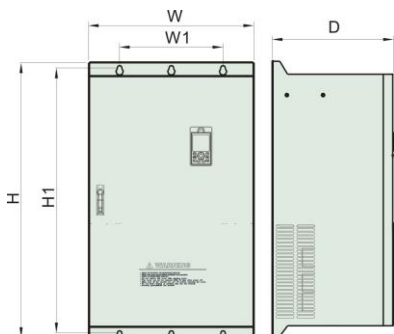

Fig 2-9

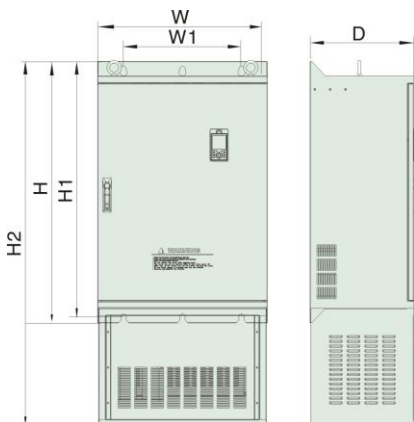

Fig 2-10 (Add base)

Inverter Model		W1 (mm)	W (mm)	H2 (mm)	H1 (mm)	H (mm)	D (mm)	Mount hole
G Type	P Type							
NE900 series/Input voltage: 380V three-phase								
NE900-4T2800G	NE900-4T3150P	500	720	1542	1047	1102	440	Φ22
NE900-4T3150G	NE900-4T3500P							
NE900-4T3500G	NE900-4T4000P	600	820	1760	1220	1270	400	Φ25
NE900-4T4000G	NE900-4T4500P							

### 2.6.5 450~800KW (Floor mouthing)

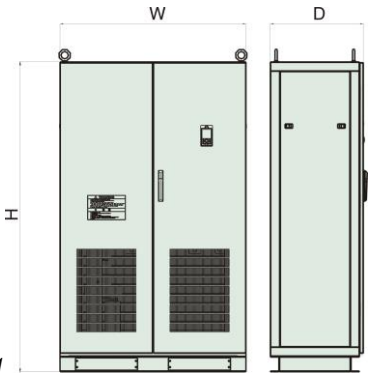

Fig 2-11

Inverter Model		W(mm)	H(mm)	D(mm)
G Type	P Type			
NE900-4T4500G	NE900-4T5000P	950	1900	475
NE900-4T5000G	NE900-4T5600P			
NE900-4T5600G	NE900-4T6300P	1200	2000	600
NE900-4T6300G	NE900-4T7100P			
NE900-4T7100G	NE900-4T8000P	1500	2000	600
NE900-4T8000G	NE900-4T9000P			

## 2.7 Optional Parts:

### 2.7.1 Braking resistor

In the NE900 series inverter, the inverter below 22KW (including 22KW) contains the braking unit. If there is energy consumption braking requirement, please select the braking resistor according to the following table. The connection of the braking resistor is shown in Figure 2-8.

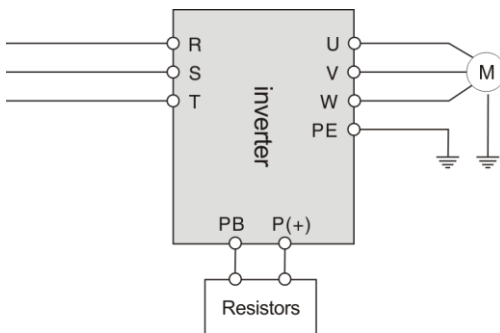

Fig 2-12 Connection diagram of the inverter and brake components

**Brake resistor selection table**

Model	Applicable motor (KW)	Resistance ( $\Omega$ )	Resistance power (W)	Braking unite
NE900-4T0007G	0.75	300	400	Built in
NE900-4T0015G	1.5	300	400	Built in

Model	Applicable motor (KW)	Resistance (Ω)	Resistance power (W)	Braking unit
NE900-4T0022G	2.2	200	500	Built in
NE900-4T0037G	4.0	200	500	Built in
NE900-4T0055G	5.5	100	800	Built in
NE900-4T0075G	7.5	75	800	Built in
NE900-4T0110G	11	50	1000	Built in
NE900-4T0150G	15	40	1500	Built in
NE900-4T0185G	18.5	30	4000	Built in
NE900-4T0220G	22	30	4000	Built in
NE900-4T0300G	30	20	6000	Built in or External
NE900-4T0370G	37	16	9000	Built in or External
NE900-4T0450G	45	13.6	9000	External
NE900-4T0550G	55	20*2	12000	External
NE900-4T0750G	75	13.6*2	18000	External
NE900-4T0900G	90	20*3	18000	External
NE900-4T1100G	110	20*3	18000	External
NE900-4T1320G	132	20*4	24000	External
NE900-4T1600G	160	13.6*4	36000	External
NE900-4T1850G	185	13.6*4	36000	External
NE900-4T2000G	200	13.6*5	45000	External
NE900-4T2200G	220	13.6*5	45000	External
NE900-4T2500G	250	13.6*5	45000	External
NE900-4T2800G	280	13.6*6	54000	External
NE900-4T3150G	315	13.6*6	54000	External
NE900-4T3500G	350	13.6*7	63000	External
NE900-4T4000G	400	13.6*8	72000	External
NE900-4T4500G	450	13.6*8	90000	External

---

## Chapter 3 Installation and Wire Connection

### 3.1 Mechanical installation

#### 3.1.1 Installation Environment

- ◆ Please mount inside a well-ventilated location. The ambient temperature is required to be within the range of  $-10 \sim 40^{\circ}\text{C}$ . If the temperature is higher than  $40^{\circ}\text{C}$ , the inverter should be derated, at the same time the ventilation and heat dissipation should be enhanced.
- ◆ Be away from the location full of dust or metal powder, and mount in the location free of direct sunlight.
- ◆ Mount in the location free of corrosive gas or combustible gas.
- ◆ Humidity should be lower than 95% with no dew condensation.
- ◆ Mount in the location where vibration is less than  $5.9\text{m/s}^2$  ( $0.6\text{G}$ ).
- ◆ Please try to keep the inverter away from EMI source and other electronic devices which are sensitive to EMI.

#### 3.1.2 Mounting Space and Direction

- ◆ Generally in vertical way.
- ◆ For the requirements on mounting space and distance, refer to Fig.3-1.
- ◆ When several inverters are installed in one cabinet, they should be mounted in parallel with special incoming and out coming ventilation and special fans. When two inverters are mounted up and down, an air flow diverting plate should be fixed as shown in Fig.3-2 to ensure good heat dissipation.



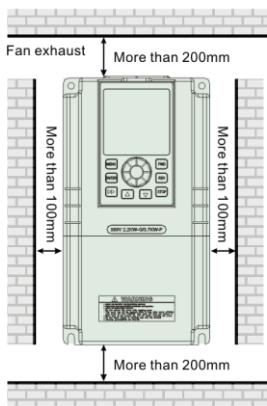

Fig.3-1 Mounting space and distance

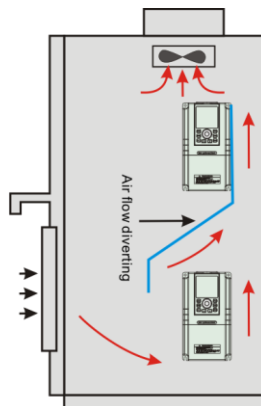



Fig.3-2 Mounting of multiple inverters

## 3.2 Standard Wiring

### 3.2.1 Wiring precautions

Security Level	Safety Precautions
 <p><b>Attention</b></p>	<ul style="list-style-type: none"> <li>◆ Before wiring, please ensure the power has been removed and be wait for at least 10minutes.</li> <li>◆ Please do not connect AC power to output terminals U/V/W.</li> <li>◆ To ensure the safety, the inverter and motor should be safety grounding. It is necessary to use copper wire above 3.5mmas ground wire, grounding resistance less than 10Ω.</li> <li>◆ The inverter has gone through voltage withstand test in factory, please do not make it again.</li> <li>◆ Solenoid switch or absorbing devices, such as ICEL, is prohibited to connect inverter output.</li> <li>◆ To provide input over current protection and for convenience in maintenance, the inverter should be connected to AC power through circuit breaker.</li> <li>◆ Please use twisted wire or shielded wire above 0.75mm for the</li> </ul>

Security Level	Safety Precautions
	wiring of relay input/output loop (X1~X6, FWD, REV, OC, DO).One end of shielding layer suspended, and the other side connected to PE grounding terminal of inverter, wiring length less than 50m .
 <p data-bbox="166 529 256 550"><b>Attention</b></p>	<ul style="list-style-type: none"> <li data-bbox="322 316 926 401">◆ The cover can be removed only when the power is switched off, all the LEDs on the panel are off and waiting at least for 10 minutes.</li> <li data-bbox="322 422 860 477">◆ Wiring work can be performed only when the DC voltage between P+ and P- terminals is lower than 36V.</li> <li data-bbox="322 498 853 552">◆ Wiring work can only be done by trained or professional personnel.</li> <li data-bbox="322 573 876 628">◆ Before usage, check whether the mains voltage meets the requirement of inverter input voltage.</li> </ul>

### 3.2.2 Main circuit wiring

#### 3.2.2.1 Main circuit wiring diagram

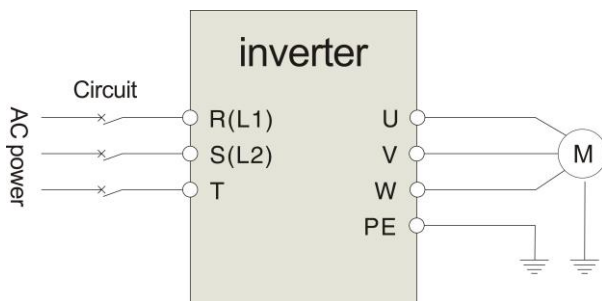

Fig. 3-3 Main circuit wiring

### 3.2.2.2 Schematic diagram of the main circuit terminal





Apply to	Main circuit terminal	Terminal name	Function
220V single phase 0.4KW~2.2KW	 <p>I1 I2 E U V W</p>	L1、L2	220V single phase Input terminals
		U、V、W	380V 3 phase Output terminals
		E	Earthing
380V 3 phase 0.75KW~1.5KW	 <p>PB R S T ⊕ U V W</p>	R、S、T	380V 3 phase Input terminals
		U、V、W	380V 3 phase Output terminals
		P+、PB	Braking resistor wiring terminals
380V 3 phase 2.2KW~3.7KW	 <p>R S T ⊕ U V W PB</p>	R、S、T	380V 3 phase Input terminals
		U、V、W	380V 3 phase Output terminals
		P+、PB	Braking resistor wiring terminals
380V 3 phase 5.5KW~22KW	 <p>R S T P+ P- PB U V W E</p>	R、S、T	380V 3 phase Input terminals
		U、V、W	380V 3 phase Output terminals
		P+、PB	Braking resistor wiring terminals
380V 3phase 30KW~630KW	 <p>R S T P+ P- U V W E</p>	R、S、T	380V 3 phase Input terminals
		U、V、W	380V 3 phase Output terminals
		P+、P-	Braking resistor wiring terminals

Table 3-1 Description of Main Circuit input/output terminals

### 3.2.3 Basic Wiring Diagram

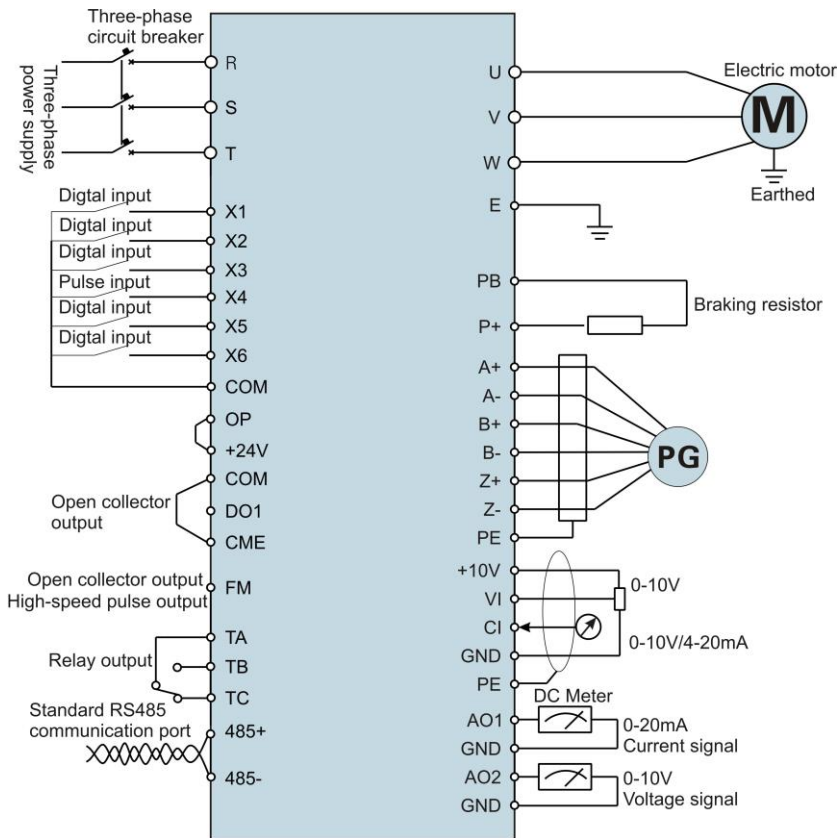

Fig. 3-4 Basic Wiring Diagram

### 3.2.4 Control loop configuration and wiring

#### 3.2.4.1 Jumper switch and control board terminal position and function introduction

The relative positions of the jumpers and terminals on the control board are shown in Figure 3-5. For the function and setting parameters of each jumper switch, see Table 3-2. For the

function description of each terminal, see Table 3-3. Before the inverter is put into use, all the jumper switches on the terminal wiring and setting control board should be correctly performed. It is recommended to use more than 1mm wire as the terminal connection line.

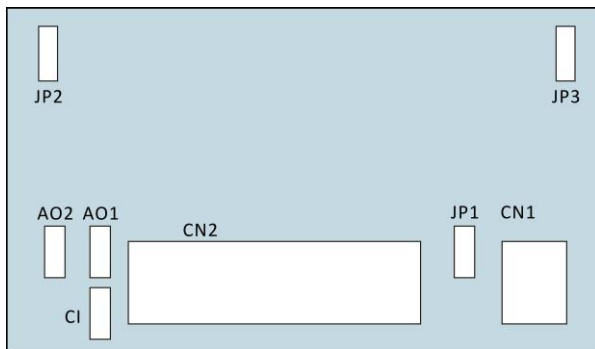

Fig. 3-5 Position of terminals and jumpers on control circuit

### 3.2.4.2 Jumper switch

NO	Function Setting Factory	Setting	FD
JP1	COM and CME connecting selection	1-2 connection: COM and CME connected 2-3 connection: COM and CME disconnected	COM and CME connection
JP2	GND and shell ground connection filter selection	1-2 connection: GND and E (Earthing) disconnected 2-3 connection: GND and E (Earthing) connected	1-2 connection
JP3	COM and shell ground connection filter selection	1-2 connection : COM and E (Earthing) disconnected 2-3 connection : COM and E (Earthing) connected	2-3 connection
AO1	AO1 terminal current/voltage output selection	I side connection: AO1: 0~20MA or 4~20MA output V side connection: AO1: 0~10V output	0-10V output
AO2	AO2 terminal current/voltage output selection	I side connection: AO2: 0~20MA or 4~20MA output V side connection: AO2: 0~10V output	0-10V output

NO	Function Setting Factory	Setting	FD
CI	CI terminal current/ voltage input selection	I side connection: CI: 0~20MA or 4~20MA input V side connection: CI: 0~10V input	0-10V input

Table 3-2 Jumper switch function table

### 3.2.4.3 Control board terminal CN1

Sort	Terminal	Setting	Factory Default
Relay output terminal	TA/RA	Can be defined as multifunctional relay output terminal by programming, refer to Chapter 6.5 P4.12, P4.13 output terminal function introduces	TA-TC: Normal close
	TB/RB		TA-TB: Normal open contact capacity
	TC/RC		AC250V/2A (COSΦ=1) AC250V/1A (COSΦ=0.4) DC30V/1A

Table 3-3 Control board CN1 terminal function table

### 3.2.4.4 Control board terminal CN2

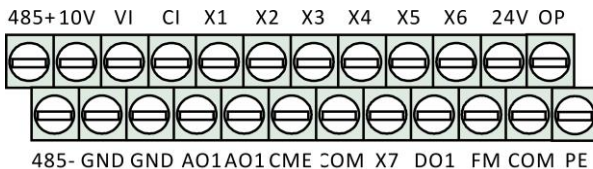

Fig. 3-6 Sequence diagram of control board terminal

Sort	Terminal	Name	Function	Specification
Commu- nication	485+	RS485 interface	RS485 differential signal positive terminal	Twisted or shielded wire needed
	485-		RS485 differential signal negative terminal	
Digital output	DO1-CME	Open collector output terminal 1	Optical coupling isolation, dual polarity open collector output Note: CME and COM are internally insulated, but they are shorted by jumper JP1 on control board. DO1 is driven by +24 V by default. If you want to drive DO1 by external power supply, remove the JP1	Couple output Output voltage range: 0–24 V Output current range: 0–50 mA Refer to P4.0 2
Pulse output	FM-COM	Open collector pulse output terminal	The programmable multi function terminal defined by P4.06 (FM input mode selection), As open-collector output, its specification is the same as that of DO1. ( Common terminal: COM)	Output range defined by P4.09, Max 100KHz
Analog input	VI	Analog input VI	Analog voltage input (Common terminal: GND)	Input voltage range: 0~10V (Impedance: 10K $\Omega$ ) Resolution: 1/1000
	CI	Analog input CI	Analog voltage/ current input, voltage/ current selected by Jumper CI, voltage input as default (Common terminal: GND)	Input voltage range: 0~10V ( Impedance: 10K $\Omega$ ) Input current range: 0~20mA (Impedance: : 500 $\Omega$ ) Resolution: 1/1000
Analog output	AO1	Analog output AO1	Analog voltage/ current output, voltage/ current selected by Jumper AO1, voltage output as default. (Common terminal: GND)	Current output range: 4~20mA Voltage output range: 0~10V

Sort	Terminal	Name	Function	Specification
	AO2	Analog output AO2	Analog voltage/ current output, voltage/ current selected by Jumper AO2, voltage output as default. (Common terminal: GND).	Current output range: 4~20mA Voltage output range: 0~10V
	X1	Multifunctional input terminal 1	Can be defined as multifunctional on-off input terminal by programming, refer to Chapter 6.5 (P3 group) .  (Common terminal: COM)  In addition to the features of the X input terminal function, the X5 can also be used as a high-speed pulse input channel.	Optical coupling isolation, compatible dual polarity input Input impedance: R=2 KΩ Max input frequency: 200Hz Input voltage range: 9~30V
	X2	Multifunctional input terminal 2		
	X3	Multifunctional input terminal 3		
	X4	Multifunctional input terminal 4		
	X5	Multifunctional input terminal 5		
	X6	Multifunctional input terminal 6		
Power	P24	+24V common terminal	Supply +24V power (negative terminal: COM)	
	OP	External power supply	Default external power+24V When using external power supply for terminal X1~X6, OP have to connect to external power. And remove the Jumper of OP and +24V terminal	
	10V	+10V power	Supply+10V power (negative terminal: GND)	Max. output current: 50mA



Sort	Terminal	Name	Function	Specification
	GND	+10V common terminal	Grounding of analog signal and +10V power source	Terminal COM and GND are isolated inside
	COM	+24V common terminal	Digital signal input, output common terminal	

Table 3-4 Control board CN2 terminal function table (continued above)

### 3.2.5 Analog Input/Output Terminal Wiring

(1) Analog voltage signal input through VI terminal as follow wiring:

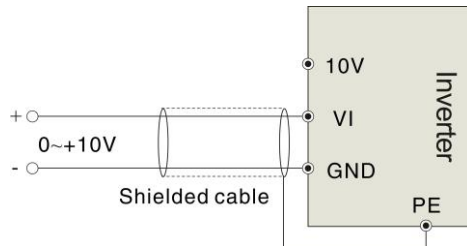

Fig. 3-7 VI terminal wiring

(2) Analog signal input through CI terminal, jumper selection for input voltage (0~10V) or input current (4~20mA) as follow wiring:

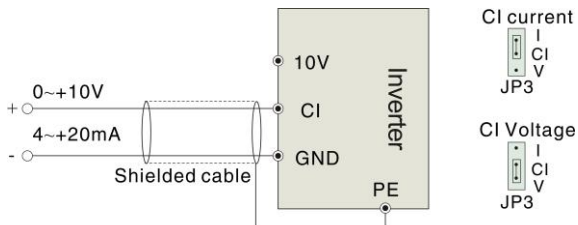

Fig. 3-8 CI terminal wiring

### (3) Analog output terminal AO1 wiring

Analog output terminal can be connected with external analog meter indicating various physical quantity, jumper selection for output voltage (0~10V) or output current (4~20mA) as follow wiring:

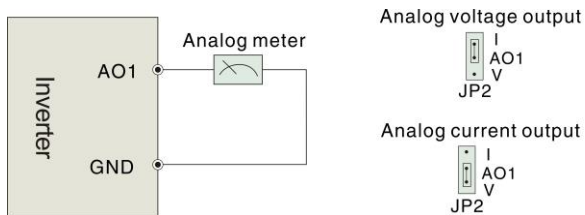

Fig. 3-9 Analog output terminal wiring

### (4) Digital output terminal DO wiring

When DO connect to relay, the replay have to connect with diode. Otherwise terminal 24Vpower source may damage. The current should be less than 50mA

**Note:**

*The connection of Diode pole should be correct, otherwise terminal 24V power source will damage.*

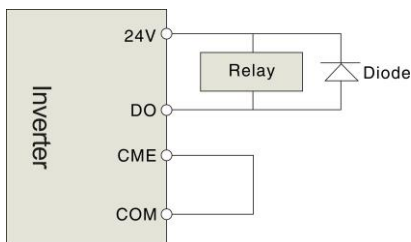

Figure 3-10 Schematic diagram of the digital output terminal wiring

**Notes:**

(1) Filter capacitor or common-mode inductor can be installed between VI and GND terminal or CI and GND terminal when using analog input mode.

(2) Please use shielded cable and do well grounding, keep the wire as short as possible in order to prevent external interference when using analog input/output mode.

### 3.2.6 Communication Terminal Wiring

The inverter supplies standard RS 485 communication port

It can constitute one master one slave control system or a one master multi slaves system. The upper computer (PC/PLC) can real time monitor the inverter in the control system and achieve complicated control function such as remote control and spermatic, etc

(1) Remote control panel can be connected with inverter viaRS485port by plugging in the remote control panel into RS485 port without any parameter setting. The local control panel of inverter and remote control panel can work at the same time.

(2) Inverter RS 485 port and upper computer wiring as follow:

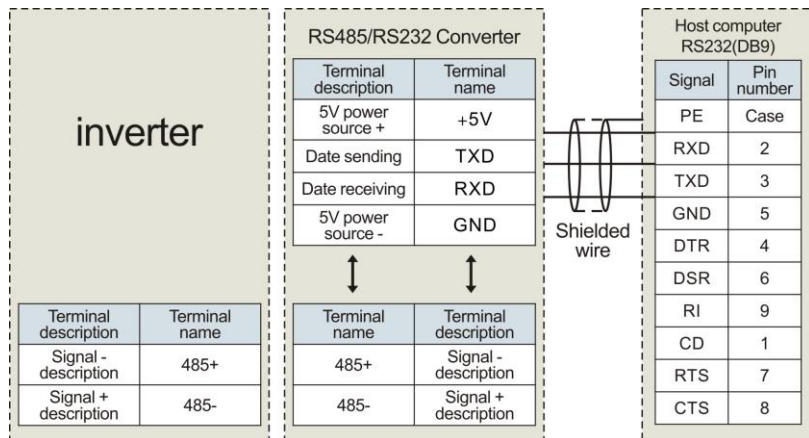

Fig. 3-11 RS485-(RS485/232)-RS232 communication wiring

(3) Multi inverters can communicate via RS485, controlled by PC/PLC as a Master shown as Fig.3-12. It also can be controlled by one of inverters as a Master shown as Fig.3-13

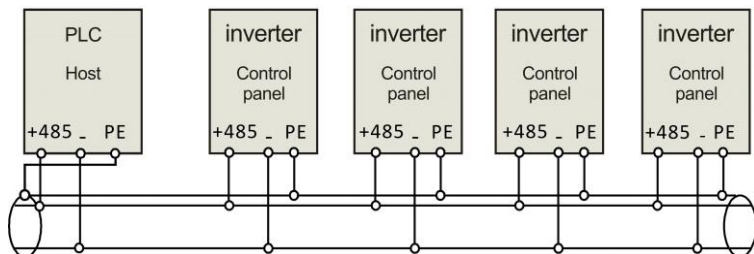

Fig. 3-12 PLC communication with multi inverters

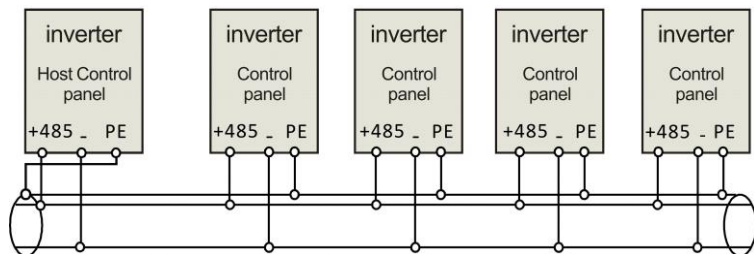

Fig. 3-13 Multi inverters communication

The more inverters connected, the more the communication interference may occur. Please make wiring as above and do well grounding for inverters and motors, or adopt the following measures to prevent interference as even above wiring can't work.

- (1) Separately power supply to PC/PLC or isolated the power of PC/PLC.
- (2) Use EMIFIL to the wire or reduce carrier frequency properly

### 3.3 EMC Installation Instruction

Inverter outputs PWM wave, it will produce electromagnetic noise. To reduce the interference, EMC installation will be introduced in this section from noise suppression, wire connection, grounding, leakage current and filter of power supply

### 3.3.1 Noise Suppression

Noise is unavoidable during inverter operation. Its influence over peripheral equipment is related to the noise type, transmission means, as well as the design, install action, wiring and grounding of the driving system

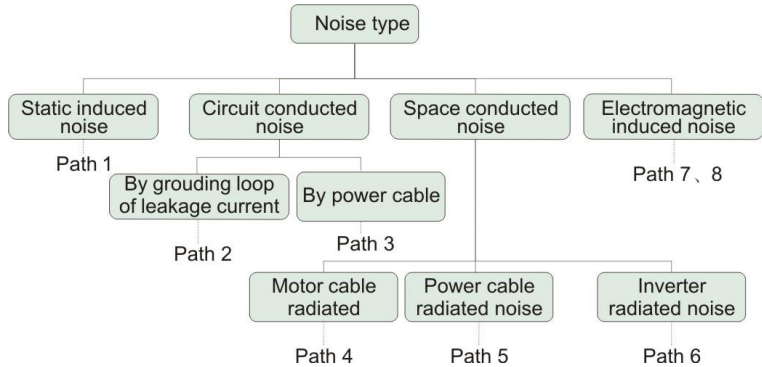

### (2) Noise Suppression Methods

Path	Noise suppression methods
Path 2	If a closed loop is formed between the peripheral equipment and the inverter wiring, the grounding leakage of the inverter will misoperate the equipment. Solution: Remove the grounding of the peripheral equipment.
Path 3	When peripheral equipment shares the same power source with the inverter, the noise transmitted through the power line may misoperate the peripheral equipment. Solution: Mount a noise filter at inverter input side or isolated the peripheral equipment with an isolated transformer or power filter.

Path	Noise suppression methods
Path 4 Path 5 Path 6	<p>Equipment and signal lines that are susceptible to interference should be installed as far as possible from the inverter. The signal line should be shielded. The shield should be grounded at one end and should be as far away as possible from the inverter and its input and output lines. If the signal wires must intersect the high-voltage cable, they should be orthogonal</p> <p>A high-frequency noise filter (ferrite common mode choke) is installed at the root of the input and output sides of the inverter to effectively suppress the radio frequency interference of the power line.</p> <p>The motor cable should be placed in a barrier of greater thickness, such as a pipe of greater thickness (more than 2 mm) or embedded in a cement tank. The power cable is inserted into the metal pipe and grounded with a shielded wire (the motor cable is a 4-core cable, one of which is grounded on the inverter side and the other side is connected to the motor casing).</p>
Path 1 Path 7 Path 8	<p>Avoid parallel wiring or bundling of strong and weak electric wires; try to keep away from the inverter installation equipment, and the wiring should be away from the input and output lines of the inverter. Shielded wires are used for signal and power lines. Equipment with strong electric field or strong magnetic field should pay attention to the relative installation position of the inverter, and should maintain distance and orthogonality.</p>

*Table3-5 Noise suppression method*

### 3.3.2 Wiring Connection and Grounding

- ◆ Please do not to wire motor cable (from inverter to motor) in parallel with power cable and keep at least 30cm from each other.
- ◆ Please try to arrange the motor cable through Control signal cable metal pipe or in metal wiring groove.
- ◆ Please use shielded cables control signal cable, and connect the shielding coat to PE terminal of inverter with proximal grounding to inverter.
- ◆ PE grounding cable should be directly connected to the earth plate.
- ◆ The control signal cable shouldn't be in parallel with strong electricity cable (power cable/motor cable). They should not be bent together and should be kept away as least

---

20cm from each other. If cable crossing is inevitable, please make sure it is same as Fig.3-1 4

- ◆ Please ground the control signal cable separately with power cable/motor cable.
- ◆ Please don't connect other devices to inverter power input terminals(R/S/T).

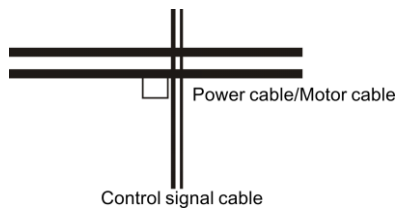

*Fig. 3-14 orthogonal wiring*

---

## Chapter 4 Operation and operation examples

### 4.1 Initial power-up

Please follow the wiring requirements in Chapter 3 "Installation and Wiring" in this manual.

After the wiring and power check are confirmed, close the AC power switch on the input side of the inverter to power on the inverter. The inverter operates the keyboard LED to display the startup dynamic screen. The contactor is normally pulled in. When the digital tube display character changes to the set frequency. When it indicates that the inverter has been initialized, the initial power-on operation process is as follows:

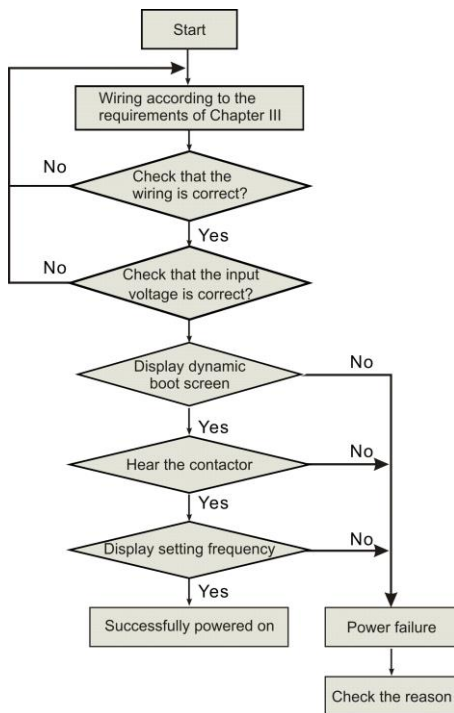





Fig. 4-1 Initial power-on operation of the inverter



## 4.2 Inverter operation

### 4.2.1 Inverter Operation Command Channel

Command Channel	Control method
Panel operatio	Use    Keys o on the panel to control the inverter.(Factory default )
Control terminal	Use one of terminals amongX1~X7 and COM to constitute a 2-wire control mode.
Serial port	<ul style="list-style-type: none"> <li>➤ Use upper computer (PC/PLC) or Master inverter to control Slave inverter to start or stop via serial port.</li> <li>➤ The command channels can be selected by setting Function Code P0.03, or by multifunctional input terminal (function code P3.00-P3.09 select 20 function).</li> </ul>

**Note:**

*When switching the command channel, please perform debugging and debugging in advance to confirm whether it can meet the requirements of the system. Otherwise, there is danger of damage to the device and personal injury.*

### 4.2.2 Inverter frequency given channel

There are 8 kinds of frequency given channels as follow:





Number	Channel	Number	Channel
0	By control panel   key, no memory after power off		
1	By control panel   key, with memory after power off		
2	Analog given via VI terminal	3	Analog given via CI terminal
4	-----	5	Pulse terminal given (PULSE)
6	Multi-segment instruction	7	Simple PLC given
8	PID given	9	Serial port setting (remote control)

Table 4-2 Frequency given channel

### 4.2.3 Inverter Running States

When inverter power on, there are two states which are Standby and running state.

Working status	Description
Standby state	When power switch on, inverter will be in standby state before receiving control command. Or receiving Stop command during inverter running, inverter will stop and standby.
Running state	After running control command is received, the inverter enters running state

### 4.2.4 Inverter operation mode

NE900 series inverters have five running modes according to priority which are JOG running, close loop running, PLC running, multi-stage speed running and normal running as shown in Fig.4-2.

Operation mode	Description
0: JOG running	In standby state, after receiving JOG running command, the inverter will run according to JOG frequency, for example, by pressing control panel  key to give JOG command(refer to function code P2.00~P3.02).
1: Close loop running	By setting close loop running control parameter enabled (P0.01=8), the inverter will enter close loop running, that is PI regulation (refer to function code P6). To make close loop running invalid, please set multifunctional input terminal (function22) and switch to lower priority running mode.
2: PLC running	By setting PLC function parameter enabled (P0.01 =7), the inverter will enter PLC running mode and run according to preset running mode (refer to function code PB).
3: Multi-stage speed running	By setting non-zero combination of multifunctional input terminal (function12,13,14, 15) and selecting multi-frequency 1-15, the inverter will enter multi-stage speed running mode (refer to function code PB.00~PB.15).
4: Normal running	Open loop running mode of inverter.

Table 4-4 Inverter operation mode

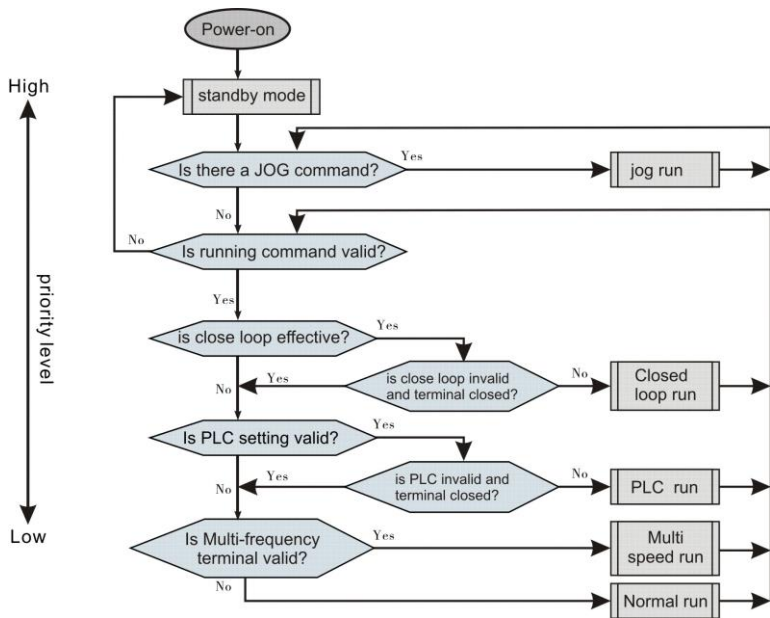

Fig. 4-2 Logical relationship diagram of inverter running status

The above 5 kinds of running modes can be running in multiple frequency setting channel except JOG running. PLC running, multi-stage speed running and normal running can carry out swing frequency running

### 4.3 Keypad introduce

#### 4.3.1 Keypad interface

The operation panel and control terminals of the inverter can control the starting, speed regulation, shutdown, braking, operating parameter setting and peripheral equipment of the motor. The operation panel is shown in Figure 4-3.













Fig. 4-3 Control panel diagram

#### 4.3.2 Keypad Function description

Name		Description	
Status light	RUN	When the light is on, the inverter is in the running state; when the light is off, the inverter is in the stop state.	
	LOCAL	<input type="radio"/> LOCAL/REMOT: Light off	Indicates that the inverter is in the stop state
		<input type="radio"/> LOCAL/REMOT: Constant on	Indicates the terminal start and stop control mode
	<input type="radio"/> LOCAL/REMOT: Twinkling	Indicates the communication start and stop control mode	
Unit indicator	Indicates the unit currently displayed on the keyboard		
	Hz	<input checked="" type="radio"/> Hz <input type="radio"/> A <input type="radio"/> V _____ RPM _____ % _____	Frequency unit
	A	<input type="radio"/> Hz <input checked="" type="radio"/> A <input type="radio"/> V _____ RPM _____ % _____	Current unit

Name	Description			
V	○ Hz	○ A	● V	Voltage unit
RPM	● Hz	● A	○ V	Speed unit
%	○ Hz	● A	● V	Percentage

Name	Description					
Digital Display Area	There are 5 5-segment LED digital tubes on the operation panel of the inverter, which display various monitoring data such as setting frequency, output frequency and alarm codes.					
	Digital Display	Corresponding Letter	Digital Display	Corresponding Letter	Digital Display	Corresponding Letter
	0	0	1	1	2	2
	3	3	4	4	5	5
	6	6	7	7	8	8
	9	9	A	a	B	b
	C	C	D	d	E	E
	F	F	H	F	I	I
	L	L	N	N	n	n
	O	o	P	P	R	r
	S	S	T	t	U	U
	U	v	.	.	-	-
Digital Potentiometer		Turn left = decrement, turn right = increment . Press potentiometer=  button.				
Operation Button		Running	Press this button for running			
		Multi-function	Default=Reverse , can change funtion via P7.00			

Name	Description		
	Stop/Reset	When VFD at normal running , press this button to stop Inverter as pre-setting way.	When VFD has fault, press this button to reset the inverter back to normal status.
	Menu/Data	Enter or exit programming status	
	Increment	Data or function code increment	
	Decrement	Data or function code decrement	
	Move/Switch	At edit status, can choose the data want to change; At other status, can switch to monitoring data display.	
	Save/Switch	At edit status, to enter next level menu or save the function code data.	

## 4.4 Display Status

The 4 display status of the inverter operation panel are stop status parameter display, function code parameter edit status display, fault alarm status display and the operating status parameter display.

### 4.4.1 Stop parameter display status

When inverter is in the stop status, the screen displays the stop status monitoring parameters. Normally display parameter is the set frequency rate. As shown in Figure 4-4 and Figure B, the unit indicator on the right side shows the unit of the parameter.

Press  Can cycleable display other stop status monitoring data (This feature is defined by the function code Pd.48)



**Figure A**

Power on to initialize the display dynamic picture



**Figure B**

Stop status, display downtime parameter



**Figure C**

Running status, showing the operating status parameters

*Fig. 4-4 Parameter display in initialization, stopping and running state*

#### 4.4.2 Running Parameter Display Status

After getting a valid running command, Inverter enters running status and the operating keyboard displays the running status monitoring parameters. The default display monitoring parameter is the output frequency (b0.00 monitoring parameter). As shown in Figure 4-4, Figure C, the unit indicator on the right shows the parameter unit.

Press  button can cycle display operation status monitoring parameters (Defined by function code P7.02&7.03)

#### 4.4.3 Fault alarm display status

When the inverter detects the fault signal, it enters the fault alarm display status and flashes the fault code (as shown in Figure 4-5).



Press  button can check related fault parameter. To check fault parameter, Press  enter program status and check PA parameter.



Fig. 4-5 Fault alarm display state

**Remark:**

For some serious faults, such as inverter module protection, over current, over voltage, etc. it is absolutely impossible to force the fault reset operation when the fault has not been confirmed and run the inverter again. Otherwise there is a danger of damage to the inverter!

**4.4.4 Function code editing status**

In the stop, run or fault alarm state, press the Menu button to enter the edit status (if the user password is set, you need to enter the password to edit, see Pd.00 description and Figure 4-9), edit status Display in the third-level menu mode, as shown in Figure 4-6. The order is: function code group - function code number - function code parameter, press enter to return previous menu without saving data.

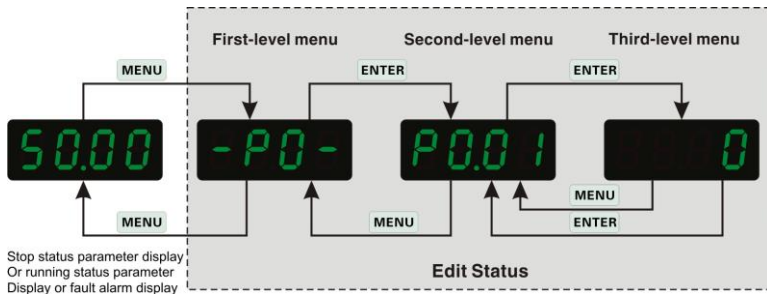



Fig.4-6 Operation panel programming display status



## 4.5 Keyboard operation

Various operations can be performed on the inverter through the operation panel, for example as follows:

### 4.5.1 Switching of status parameters display

After pressing the  key, the parameter value of the monitoring parameter is automatically switched.

The switching method is shown in Figure 4-7. Display content is determined by P7.02 and P7.03.

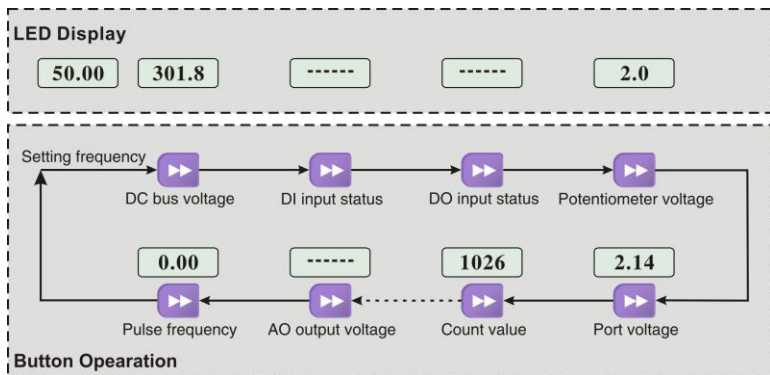

Fig.4-7 Example for running status data display operation

### 4.5.2 Function Code Setting

Example of setting Function Code P2.09 from 5.00Hz to 8.5Hz.

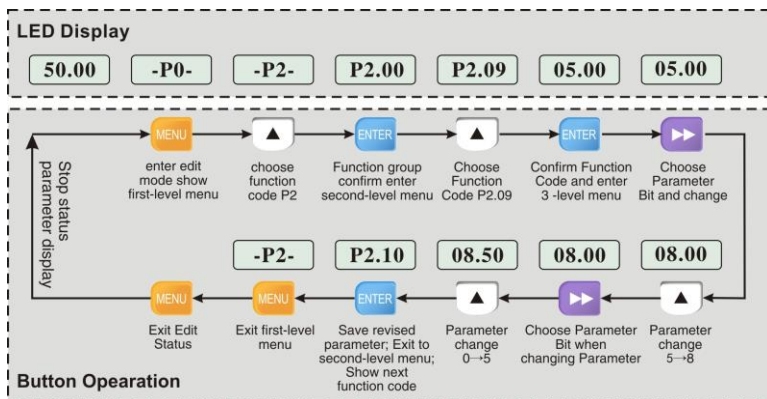

Fig.4-8 Parameter editing operation example

**Remark:**

In the three-level menu status, if the parameter has no flashing bit, it means the function code cannot be modified. The possible reasons are as follows:

The function code is an unmodifiable parameter, such as an actual detected status parameter, a running record parameter, etc.

The function code cannot be modified in the running status, and can be modified after stopping.

**4.5.3 Jog Running Operation**

Assume that the current running command channel is the operation panel, at the stop state, and the jog running frequency is 5 Hz. For example:

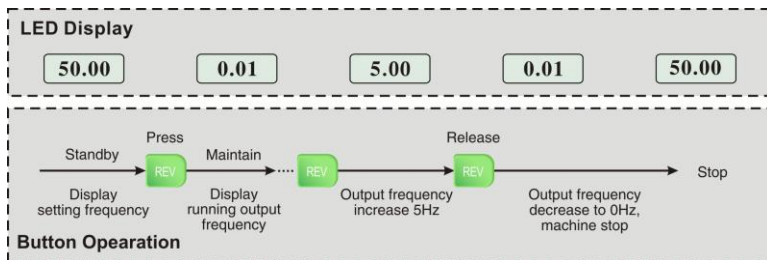

Fig.4-9 Jog run operation example

#### 4.5.4 Set the password unlock operation for the user password

Assume that the "user password" Pd.00 has been set to "2345". The bold numbers in Figure 4-10 indicate the flash bits.

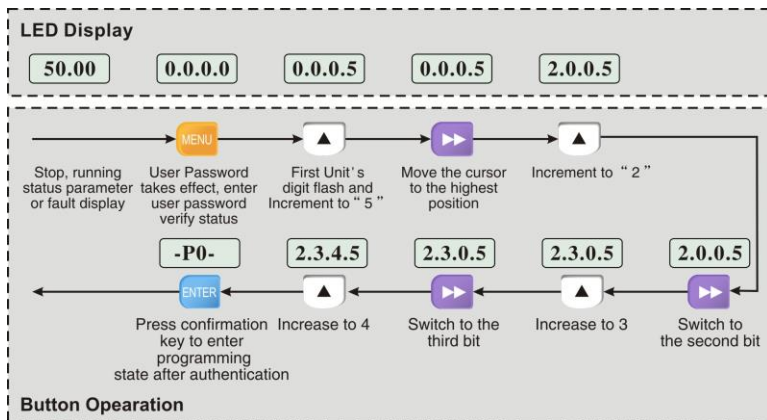

Fig.4-10 Example of entering a user password to enter a function code operation

#### 4.5.5 Fault Status Query Fault Parameters

##### Remark:

When the user queries the fault parameters, you can view the function codes PA.14~PA.40 to view the three sets of fault record information.

#### 4.5.6 Set frequency keyboard up / down button fix function

Assume that the current stop parameter display status, P0.01=1, is as follows:

1. Frequency adjustment adopts integral method;
2. When the upper button is pressed, the LED unit's digit starts to increase. When it is increased to the ten's digit, the ten's digit starts to increase. When the ten's digit increases to the hundred's digit to the hundred's digit, the hundred's digit starts to increase, analogy. If you press the up button and then press the button again, it starts to re-increment from the LED unit's digit.
3. When press the down button, the LED unit's digit begins to decrease. When decrease to the borrow from ten's digit, the ten's digit begins to decrease. When the ten's digit is decreased to borrow from the hundred's digit, the hundred's digit begins to decrease, and so on. If you release the down button and press the button again, it starts to decrease from the LED Unit's digit.

## Chapter 5 Property description

### 5.1 Property description

“○” : The parameter can be modified when the AC drive is in either stop or running state.

“×” : The parameter can not be modified when the AC drive is in the running state.

“\* ”: The parameter is factory parameter and can not be modified.

### 5.2 Standard Function Parameters

Function Code	Parameter Name	Setting Range	Minimum Unit	Default	Property
<b>Group P0: Standard Function Parameter</b>					
P0.00	Control mode	0: V/F control 1: Sensorless vector control(SVC) 2: Sensor vector control(FVC)	1	0	×
P0.01	Main frequency source 1 selection	0: Digital setting 1(P0.02, UP/DOWN can modify,non-retentive at power failure) 1: Digital setting 2(P0.02, UP/DOWN can modify,retentive at power failure) 2: VI analog setting (VI-GND) 3: CI analog setting (CI-GND) 5: Pulse setting 6: Multi-reference 7: Simple PLC 8: PID 9: 485 communication	1	0	×
P0.02	Setting running frequency	P0.07lower limit frequency~ P0.06 upper limit frequency	0.01Hz	50.00Hz	○
P0.03	Command source selection	0: Operation panel control (LED off) 1: Terminal control (LED on) 2: Communication control (LED blinking)	1	0	○
P0.04	Rotation direction	0: Same direction 1: Reverse direction	1	0	○

Function Code	Parameter Name	Setting Range	Minimum Unit	Default	Property
P0.05	Maximum frequency	50.00Hz~5000.00Hz	0.01Hz	50.00Hz	×
P0.06	Frequency upper limit	Frequency lower limit to maximum frequency (P0.05)	0.01Hz	50.00Hz	○
P0.07	Frequency lower limit	0.00Hz to frequency upper limit(P0.06)	0.01Hz	0.00Hz	○
P0.08	Source of frequency upper limit	0: Set by P0.02 1:VI 2:CI 4: X5 PULSE setting 5: Communication setting	1	0	×
P0.09	Frequency upper limit offset	0.00Hz to maximum frequency (P0.05)	0.01Hz	0.00Hz	○
P0.10	Carrier frequency	0.5KHz~16.0KHz	0.1KHz	Model dependent	○
P0.11	Carrier frequency adjustment with temperature	0: No 1: Yes	1	0	○
P0.12	Acceleration time 0	0.1~6000.0s	0.1s	Model dependent	○
P0.13	Deceleration time 0	0.1~6000.0s	0.1s	Model dependent	○
P0.14	Acceleration/Deceleration time unit	0: 1s 1: 0.1s 2: 0.01s	1	1	×
P0.15	Acceleration/Deceleration time base frequency	0: Maximum frequency (P0.05) 1: set frequency 2: 100Hz 3: Basic frequency of motor	1	0	×
P0.16	Auxiliary frequency source 2 selection	The same as P0.01(Main frequency source 1 selection)	1	0	×
P0.17	Basic value of auxiliary frequency when overlay	0: Relative to maximum frequency 1: Relative to main frequency	1	0	○
P0.18	Range of auxiliary frequency 2 for 1 and 2 operation	0%-150%	0%	100%	○
P0.19	Frequency source overlay selection	Unit's digit: (Frequency source selection) 0: Main frequency source 1 1: Main and Aux operation	01	00	○

Function Code	Parameter Name	Setting Range	Minimum Unit	Default	Property
		(operation relationship determined by ten's digit) 2: Switchover between main source 1 and Aux source 2 3: Switchover between main source 1 and operation result of Main+Aux 4: Switchover between source 2 and operation result of Main+Aux Ten's digit (Main & Aux frequency operation relationship) 0: Main+Aux 1: Main - Aux 2: Maximum value of Main&Aux 3: Minimum value of Main & Aux			
P0.20	Frequency offset of auxiliary frequency source for 1 and 2 operation(overlay)	0.00Hz to maximum frequency (P0.05)	0.01Hz	0.00Hz	○
P0.21	Frequency command resolution	1: 0.1Hz 2: 0.01Hz When change frequency command decimal point, pls also change max frequency, upper limit frequency etc	1	2	×
P0.22	Digital setting frequency memory selection	Units: Stop memory selection 0: no memory 1: Memory Tens place: memory selection when PB51 is pre-made frequency 0: no memory 1: Memory	1	0	○
P0.23	Modification during running Base frequency for UP/DOWN	0: Running frequency 1: Set frequency	0	0	×

Function Code	Parameter Name	Setting Range	Minimum Unit	Default	Property
P0.24	Binding command source to frequency source	Unit's digit (binding operation panel command to frequency source) 0: No binding 1: Frequency source by digital setting 2: VI setting (VI-GND) 3: CI setting (CI-GND) 5: PULSE setting 6: Multi-reference 7: Simple PLC 8: PID setting 9: 485 communication setting Ten's digit: Binding terminal command to frequency source Hundred's digit: Binding communication command to frequency source Thousand's digit: Binding running command to frequency source	0001	0000	○
P0.25	G/P type setting	1: G type 2: P type	1	Model dependent	•
P0.27	Serial communication protocol	0:MODBUS protocol	1	0	×
<b>Group P1: Start/Stop Parameter</b>					
P1.00	Start mode	0: Direct start 1: Rotational speed tracking restart 2: Pre-excited start	1	0	○
P1.01	Startup frequency	0.00~10.00Hz	0.01Hz	0.00Hz	○
P1.02	Startup frequency holding time	0.0~100.0s	0.1s	0.0s	×
P1.03	Startup DC braking current/ Pre-excited current	0%~100%	1%	0%	×
P1.04	Startup DC braking time/ Pre-excited	0.0~100.0s	0.1s	0.0s	×

Function Code	Parameter Name	Setting Range	Minimum Unit	Default	Property
	time				
P1.05	Stop mode	0: Decelerate to stop 1: Natural stop	1	0	○
P1.06	Initial frequency of stop DC braking	0.00Hz to maximum frequency	0.00Hz	0.00Hz	○
P1.07	Waiting time of stop DC braking	0.0~100.0s	0.1s	0.0s	○
P1.08	DC braking time when stop	0.0~100.0s	0.1s	0.0s	○
P1.09	DC braking Current when stop	0%~100%	1%	0%	○
P1.10	Braking unit use ratio	0%~100%	1%	100%	○
P1.11	Rotational speed tracking mode	0: From frequency at stop 1: From zero speed 2: From maximum frequency	1	0	×
P1.12	Rotational speed tracking speed	1~100	1	20	○
P1.13	Acceleration/Deceleration mode	0: Linear acceleration/ deceleration 1: S-curve acceleration/ deceleration	1	0	×
P1.14	Time proportion of S-curve start segment	0.0%~ (100.0%~P1.15)	0.1%	30.0%	×
P1.15	Time proportion of S-curve end segment	0.0%~ (100.0%~P1.14)	0.1%	30.0%	×
<b>Group P2: Auxiliary Functions</b>					
P2.00	JOG running frequency	0.10 Hz to maximum frequency	0.01Hz	5.00Hz	○
P2.01	JOG acceleration time	0.1~6500.0s	0.1s	Model dependent	○
P2.02	JOG deceleration time	0.1~6500.0s	0.1s	Model dependent	○
P2.03	Acceleration time 1	0.1~6500.0s	0.1	Model dependent	○
P2.04	Deceleration time 1	0.1~6500.0s	0.1	Model dependent	○
P2.05	Acceleration time 2	0.1~6500.0s	0.1	Model dependent	○



Function Code	Parameter Name	Setting Range	Minimum Unit	Default	Property
P2.06	Deceleration time 2	0.1~6500.0s	0.1	Model dependent	○
P2.07	Acceleration time 3	0.1~6500.0s	0.1	Model dependent	○
P2.08	Deceleration time 3	0.1~6500.0s	0.1	Model dependent	○
P2.09	Jump frequency 1	0.0Hz to maximum frequency	0.01Hz	0.00Hz	○
P2.10	Jump frequency 2	0.0Hz to maximum frequency	0.01Hz	0.00Hz	○
P2.11	Jump frequency amplitude	0.0Hz to maximum frequency	0.01Hz	0.00Hz	○
P2.12	Forward/Reverse rotation dead-zone time	0.0s~3000.0s	0.1s	0.0s	○
P2.13	Reverse control	0: Enabled 1: Forbidden	0	0	○
P2.14	Running mode when set frequency lower than frequency lower limit	0: Run at frequency lower limit 1: Stop 2: Run at zero speed	0	0	○
P2.15	Drop control	0.00Hz~10.00Hz	0.01Hz	0.00Hz	○
P2.16	Accumulative power-on time threshold	0h~65000h	1h	0h	○
P2.17	Accumulative running time threshold	0h~65000h	1h	0h	○
P2.18	Startup protection	0: NO 1: YES	1	0	○
P2.19	Frequency detection value (FDT1)	0.00Hz to maximum frequency	0.01Hz	50.00Hz	○
P2.20	Frequency detection hysteresis (FDT1)	0.0%~100.0%(FDT1 level)	0.1%	5.0%	○
P2.21	Detection range of frequency reached	0.0%~100.0% ( maximum frequency)	0.1%	0.0%	○
P2.22	Jump frequency during acceleration /deceleration	0: Disabled 1: Enabled	1	0	○
P2.23	Frequency switchover point between acceleration	0.00Hz to maximum frequency	0.01Hz	0.00Hz	○

Function Code	Parameter Name	Setting Range	Minimum Unit	Default	Property
	time 1 and acceleration time 2				
P2.24	Frequency switchover point between deceleration time 1 and deceleration time 2	0.00Hz to maximum frequency	0.01Hz	0.00Hz	○
P2.25	Terminal JOG preferred	0: Disabled 1: Enabled	1	0	○
P2.26	Frequency detection value (FDT2)	0.00Hz to maximum frequency	0.01Hz	50.00Hz	○
P2.27	Frequency detection hysteresis (FDT2)	0.0%~100.0%(FDT2 level)	0.1%	5.0%	○
P2.28	Any frequency reaching detection value 1	0.00Hz to maximum frequency	0.01Hz	50.00Hz	○
P2.29	Any frequency reaching detection amplitude 1	0.0%~100.0% (maximum frequency)	0.1%	0.0%	○
P2.30	Any frequency reaching detection value 2	0.00Hz to maximum frequency	0.01Hz	50.00Hz	○
P2.31	Any frequency reaching detection amplitude 2	0.0%~100.0% ( maximum frequency)	0.1%	0.0%	○
P2.32	Zero current detection level	0.0 %~300.0 %(100.0% rated motor current)	0.1%	5.0%	○
P2.33	Zero current detection delay time	0.01S~600.00s	0.01s	0.10s	○
P2.34	Output overcurrent threshold	0.1 %~300.0 % (100.0% rated motor current)	0.1%	200.0%	○
P2.35	Output overcurrent detection delay time	0.01s~600.00s	0.01s	0.00s	○
P2.36	Any current reaching 1	0.0 %~300.0 %(100.0% rated motor current)	0.1%	100.0 %	○
P2.37	Any current reaching 1 amplitude	0.0 %~300.0 %(100.0% rated motor current)	0.1%	0.0 %	○
P2.38	Any current reaching 2	0.0 %~300.0 %(100.0% rated motor current)	0.1%	100.0 %	○

Function Code	Parameter Name	Setting Range	Minimum Unit	Default	Property
P2.39	Any current reaching 2 amplitude	0.0 %~300.0 %(100.0% rated motor current)	0.1%	0.0 %	○
P2.40	Timing function	0: Disabled 1: Enabled	1	0	○
P2.41	Timing duration selection	0: P2.42 setting 1: VI 2: CI Analog input range corresponds to P2.42	1	0	○
P2.42	Timing duration	0.0Min~6500.0Min	0.1Min	0.0Min	○
P2.43	VI input voltage protection lower limit	0.00V~P2.44	0.01V	3.10V	○
P2.44	VI input voltage protection upper limit	P2.44~10.00V	0.01V	6.80V	○
P2.45	Module temperature threshold	0~100℃	1	75℃	○
P2.46	Cooling fan control	0: Fan working during running 1: Fan working all the time	1	0	○
P2.51	Current running time reached	0.0~6500.0Min	0.1Min	0.0Min	○
P2.55	Motor output power adjust coefficient	0.1~2	0.1	1	○
<b>Group P3 : Input Terminals</b>					
P3.00	Input terminal X1 function selection	0: No function 1: Forward RUN (FWD) 2: Reverse RUN (REV) or FWD /REV direction 3: Three-line control 4: External Forward JOG (FJOG) 5: External Reverse JOG (RJOG) 6: Terminal UP 7: Terminal DOWN 8: Coast to stop (FRS) 9: Fault reset 10: RUN pause 11: Normally open(NO) input of external fault 12: Mult-reference terminal 1 13: Mult-reference terminal 2 14: Mult-reference terminal 3	1	1	×

Function Code	Parameter Name	Setting Range	Minimum Unit	Default	Property
		15: Mult-reference terminal 4 16: Terminal 1 for acceleration /deceleration time selection 17: Terminal 2 for acceleration /deceleration time selection 18: Frequency source switchover 19: UP/DOWN setting clear (terminal, operation panel) 20: Command source switchover 1 21: Acceleration/Deceleration prohibited 22: PID pause 23: PLC status reset 24: Swing pause 25: Counter input 26: Counter reset 27: Length count input 28: Length reset 29: Torque control prohibited 30: PULSE input enabled (only for X5) 31: Reserved 32: Immediate DC braking 33: Normally closed (NC)input of external fault 34: Frequency modification forbidden 35: Reverse PID action direction 36: External STOP terminal 1 37: Command source switchover terminal 2 38: PID integral pause 39: Switchover between main frequency source X and preset frequency 40: Switchover between main frequency source Y and preset frequency 41: Motor selection terminal 1			

Function Code	Parameter Name	Setting Range	Minimum Unit	Default	Property
		42: Reserved 43: PID parameter switchover 44: User-defined fault 1 45: User-defined fault 2 46: Speed control/Torque control switchover 47: Emergency stop 48: External STOP terminal 2 49: Deceleration DC braking 50: Clear the current running time 51: Switchover between two-line mode and three-line mode 52: Reverse forbidden 53~59: Reserved			
P3.01	X2 function selection	Same as above	1	4	×
P3.02	X3 function selection	Same as above	1	9	×
P3.03	X4 function selection	Same as above	1	12	×
P3.04	X5 function selection	Same as above	1	13	×
P3.05	X6 function selection	Same as above	1	0	×
P3.06	X7 function selection	Same as above	1	0	×
P3.07	X8 function selection	Reserved	1	0	×
P3.08	X9 function selection	Reserved	1	0	×
P3.09	X10 function selection	Reserved	1	0	×
P3.10	VI function selection (DI)	0~59	1	1	×
P3.11	CI function selection (DI)	0~59	1	1	×
P3.13	Terminal filter time	0.000s~1.000s	1	0.010s	×
P3.14	Terminal command mode	0: Two-line mode 1 1: Two-line mode 2 2: Three -line mode 1 3: Three -line mode 2	0	0	○
P3.15	Terminal UP/DOWN rate	0.001Hz/s~65.535Hz/s	0.001Hz/s	1.00Hz/s	○
P3.16	VI minimum input	0.00V~P3.15	1	0.00V	○
P3.17	Corresponding setting of VI minimum input	-100.0%~+100.0%	1	0.0%	○

Function Code	Parameter Name	Setting Range	Minimum Unit	Default	Property
P3.18	VI maximum input	P3.13~+10.00V	0.01V	10.00V	○
P3.19	Corresponding setting of VI maximum input	-100.0%~+100.0%	0.01%	100.0%	○
P3.20	VI filter time	0.00s~10.00s	0.01s	0.10s	○
P3.21	CI minimum input	0.00V~P3.20	0.01V	0.00V	○
P3.22	Corresponding setting of CI minimum input	-100.0%~+100.0%	0.1%	0.0%	○
P3.23	CI maximum input	P3.18~+10.00V	0.01V	10.00V	○
P3.24	Corresponding setting of CI maximum input	-100.0%~+100.0%	0.0%	100.0%	○
P3.25	CI filter time	0.00s~10.00s	0.01s	0.10s	○
P3.31	Pulse minimum input	0.00KHz ~ P3.30	0.00KHz	0.00KHz	○
P3.32	Corresponding setting of pulse minimum input	-100.0%~+100.0%	0.1%	0.0%	○
P3.33	Pulse maximum input	P3.28 ~100.00KHz	0.01Hz	50.00KHz	○
P3.34	Corresponding setting of pulse maximum input	-100.0%~+100.0%	0.1%	100.0%	○
P3.35	Pulse filter time	0.00s~10.00s	0.01s	0.10s	○
P3.36	VI curve selection	Unit's digit: VI curve selection 1: Curve1 (2 points, see P3.16~P3.19) 2: Curve 2 (2 points, see P3.21~P3.24) 3: Curve 3 (2 points, see P3.26~P3.29) 4: Curve 4 (4 points, see PF.20~PF.27) 5: Curve 5 (4 points, see PF.28~PF.35) Ten's digit: CI curve selection, same as VI	111	321	○
P3.37	Setting for AI less than minimum input	Unit's digit: setting for VI less than minimum input 0: Minimum value 1: 0.0% Ten's digit: setting for CI less	111	000	○

Function Code	Parameter Name	Setting Range	Minimum Unit	Default	Property
		than minimum input			
P3.38	X1 delay time	0.0s~3600.0s	0.1s	0.0s	×
P3.39	X2 delay time	0.0s~3600.0s	0.1s	0.0s	×
P3.40	X3 delay time	0.0s~3600.0s	0.1s	0.0s	×
P3.41	X valid mode selection 1	0: High level valid 1: Low level valid Unit's digit: X1 Ten's digit: X2 Hundred's digit: X3 Thousand's digit: X4 Ten thousand's digit: X5	11111	00000	×
P3.42	X valid mode selection 2	0: High level valid 1: Low level valid Unit's digit: X6 Ten's digit: X7 Hundred's digit: X8 Thousand's digit: X9 Ten thousand's digit: X10	11111	00000	×
P3.43	AI as valid status selection	0: High level valid 1: Low level valid Unit's digit: VI Ten's digit: CI	111	111	×
P3.44	Input phase loss judgment time	0.1~6553.5	0.1	5.0	×
<b>Group P4: Output Terminals</b>					
P4.00	FM terminal output mode	0: Pulse output (FMP) 1: Switch signal output (FMR)	1	0	○
P4.01	FM open-switch output function selection	0: No output 1: inverter running 2: Fault output (stop)	1	0	○
P4.02	Relay function T/A-T/B-T/C	3: Frequency-level detection FDT1 output	1	2	○
P4.03	Extension card relay function (R/A-R/B-R/C)	4: Frequency reached 5: Zero-speed running (no output at stop)	1	0	○
P4.04	DO1 function selection (Reserved)	6: Motor overload pre-warning 7: inverter overload pre-warning	1	1	○
P4.05	DO2 function selection (Reserved)	8: Set count value reached 9: Designated count value reached 10: Length reached 11: PLC cycle complete			

Function Code	Parameter Name	Setting Range	Minimum Unit	Default	Property
		12: Accumulative running time reached 13: Frequency limited 14: Torque limited 15: Ready for RUN 16: VI > CI 17: Frequency upper limit reached 18: Frequency lower limit reached 19: Under voltage state output 20: Communication setting 21: Positioning complete 22: Positioning approach 23: Zero-speed running 2 (having output at stop) 24: Accumulative power-on time reached 25: Frequency level detection FDT2 output 26: Frequency 1 reached 27: Frequency 2 reached 28: Current 1 reached 29: Current 2 reached 30: Timing reached 31: VI input limit exceeded 32: Load becoming 0 33: Reverse running 34: Zero current state 35: Module temperature reached 36: Software current limit exceeded 37: Frequency lower limit reached (having output at stop) 38: Alarm output (all faults) 39: Motor overheat warning 40: Current running time reached 41: Fault output (there is no output if it is the coast to stop)			



Function Code	Parameter Name	Setting Range	Minimum Unit	Default	Property
		fault and under voltage occurs )			
P4.06	FMP output function selection	0: Running frequency	1	0	1
P4.07	AO1 function selection	1: Set frequency 2: Output current 3: Output torque	1	0	1
P4.08	AO2 function selection	4: Output power 5: Output voltage 6: Pulse input ( 100.0% at 100.0KHz ) 7: VI 8: CI 10: Length 11: Count value 12: Communication setting 13: Motor rotational speed 14: Output current ( 100.0% at 1000.0A ) 15: Output voltage ( 100.0% at 1000.0V ) 16: Output torque (actual value)	1	1	1
P4.09	Maximum FMP output frequency	0.01KHz~100.00KHz	0.01KHz	50.00KHz	○
P4.10	AO1 offset coefficient	-100.0%~+100.0%	0.001	0.0%	○
P4.11	AO1 gain	-10.00~+10.00	0.01	1.00	○
P4.12	AO2 offset coefficient	-100.0%~+100.0%	0.001	0.0%	○
P4.13	AO2 gain	-10.00~+10.00	0.01	1.00	○
P4.14	FMR output delay time	0.0s~3600.0s	0.1s	0.0s	○
P4.15	Relay 1 output delay time	0.0s~3600.0s	0.1s	0.0s	○
P4.16	Relay 2 output delay time	0.0s~3600.0s	0.1s	0.0s	○
P4.17	DO1 output delay time	0.0s~3600.0s	0.1s	0.0s	○
P4.18	DO2 output delay time	0.0s~3600.0s	0.1s	0.0s	○
P4.19	Switch output terminal valid status	0: Positive logic 1: Negative logic Unit's digit: FMR Ten's digit: RELAY1	11111	00000	○

Function Code	Parameter Name	Setting Range	Minimum Unit	Default	Property
		Hundred's digit: RELAY2 Thousand's digit DO1 Ten thousand's digit: DO2			
Group P5: V/F Curve Control Parameters					
P5.00	V/F curve setting	0: Linear V/F 1: Multi-point V/F 2: Square V/F 3:1.2-power V/F 4:1.4-power V/F 6:1.6-power V/F 8:1.8-power V/F 9: Reserved 10: V/F complete separation 11: V/F half separation	1	0	×
P5.01	Torque boost	0.0%(automatic torque boost) 0.1%~30.0%	--	Model depend	○
P5.02	Cut-off frequency of torque boost	0.00Hz to maximum output frequency	0.01Hz	50.00Hz	×
P5.03	Multi-point V/F frequency 1	0.00Hz~P5.05	0.01Hz	0.00Hz	×
P5.04	Multi-point V/F voltage 1	0.0%~100.0%	0.1%	0.0%	×
P5.05	Multi-point V/F frequency 2	P5.03~P5.07	0.01Hz	0.00Hz	×
P5.06	Multi-point V/F voltage 2	0.0%~100.0%	0.1%	0.0%	×
P5.07	Multi-point V/F frequency 3	P5.05 to rated motor frequency	0.01Hz	0.00Hz	×
P5.08	Multi-point V/F voltage 3	0.0%~100.0%	0.1%	0.0%	×
P5.09	V/F slip compensation gain	0.0%~200.0%	0.1%	0.0%	○
P5.10	V/F over-excitation gain	0~200	1	64	○
P5.11	V/F oscillation suppression gain	0~100	1	Model depend	○
P5.13	Voltage source for V/F separation	0: Digital setting 1: VI 2: CI 4: Pulse setting	1	0	○

Function Code	Parameter Name	Setting Range	Minimum Unit	Default	Property
		5: Multi-reference 6: Simple PLC 7: PID 8: Communication setting (100.0% corresponds to the rated motor voltage)			
P5.14	Voltage digital setting for V/F separation	0V to rated motor voltage	1	0V	○
P5.15	Voltage acceleration time of V/F separation	0.0s~1000.0s	0.1s	0.0s	○
P5.13	Voltage source for V/F separation	0: Digital setting 1: VI 2: CI 4: Pulse setting 5: Multi-reference 6: Simple PLC 7: PID 8: Communication setting (100.0% corresponds to the rated motor voltage)	1	0	○
<b>Group P6: PID Function</b>					
P6.00	PID setting source	0: P6.01 setting 1: VI 2: CI 4: Pulse setting 5: Communication setting 6: Multi-reference setting	1	0	○
P6.01	PID digital setting	0.0%~100.0%	1%	50%	○
P6.02	PID feedback source	0: VI 1: CI 3: VI-CI 4: Pulse setting 5: Communication setting 6: VI+CI 7: MAX( VI + CI ) 8: MIN( VI , CI )	1	0	○
P6.03	PID action direction	0: Forward action 1: Reverse action	1	0	○
P6.04	PID setting feedback range	0~65535	1	1000	○

Function Code	Parameter Name	Setting Range	Minimum Unit	Default	Property
P6.05	Proportional gain KP1	0.0~100.0	0.1	20.0	○
P6.06	Integral time TI1	0.01s~10.00s	0.01s	2.00s	○
P6.07	Differential time TD1	0.000s~10.000s	0.001s	0.000s	○
P6.08	Cut-off frequency of PID reverse rotation	0.00 to maximum frequency	0.01 Hz	2.00Hz	○
P6.09	PID deviation limit	0.0%~100.0%	0.1%	0.0%	○
P6.10	PID differential limit	0.00%~100.00 %	0.01%	0.10%	○
P6.11	PID setting change time	0.00~650.00s	0.01s	0.00s	○
P6.12	PID feedback filter time	0.00~60.00s	0.01s	0.00s	○
P6.13	PID output filter time	0.00~60.00s	0.01s	0.00s	○
P6.14	Reserved	-	-	-	○
P6.15	Proportional gain KP2	0.0~100.0	0.1	20.0	○
P6.16	Integral time TI2	0.01s~10.00s	0.01s	2.00s	○
P6.17	Differential time TD2	0.000s~10.000s	0.001s	0.000s	○
P6.18	PID parameter switchover condition	0: No switchover 1: Switchover via Xi 2: Automatic switchover based on deviation 3: Automatic switchover based on running frequency	0.01	0	○
P6.19	PID parameter switchover deviation 1	0.0%~P6.20	0.1%	20.0%	○
P6.20	PID parameter switchover deviation 2	P6.19~100.0 %	0.1%	80.0%	○
P6.21	PID initial value	0. 0%~100.0 %	1	0. 0%	○
P6.22	PID initial value holding time	0.00~650.00s	0.01s	0.00s	○
P6.23	Maximum deviation between two PID outputs in forward direction	0.00%~100.00%	0.01%	1.00%	○
P6.24	Maximum deviation between two PID	0.00%~100.00%	0.01%	1.00%	○

Function Code	Parameter Name	Setting Range	Minimum Unit	Default	Property
	outputs in reverse direction				
P6.25	PID integral property	Unit's digit: Integral separated 0: Invalid 1: Valid Ten's digit: whether to stop integral operation when the output reaches the limit 0: Continue integral operation 1: Stop integral operation	00~11	00	○
P6.26	Detection value of PID feedback loss	0.0%: Not judging feedback loss 0.1%~100.0%	0.01Hz	0.0%	○
P6.27	Detection time of PID feedback loss	0.0s~20.0s	0.1s	1.0s	○
P6.28	PID operation at stop	0: No PID operation at stop 1: PID operation at stop	1	0	○
P6.30	Given pressure	0.001~P6.31 MPa	0.001Mpa	0.500Mpa	○
P6.31	Maximum value set by up and down keys	0.001~P6.04 MPa	0.001Mpa	1.000Mpa	○
P6.32	Minimum value set by up and down keys	0.001~P6.31 MPa	0.001Mpa	0	○
P6.33	Alarm upper limit pressure output	0.001~P6.04 MPa	0.001Mpa	1.000Mpa	○
P6.34	Alarm lower limit pressure output	0.001~P6.33 MPa	0.001Mpa	0	○
P6.35	Awakening pressure level	0.001~P6.37 MPa	0.001Mpa	0	○
P6.36	Wake-up pressure level continuous time	0.1~6500.0s	0.1S	0	○
P6.37	Sleep pressure level	0.001~P6.04 MPa	0.01Mpa	0	○
P6.38	Sleep pressure level continuous time	0.1~6500.0s	0.1S	0	○
P6.39	Sleep frequency	0.00Hz~3200.0Hz	0.01Hz	25.00Hz	○
P6.40	Sleep frequency continuous time	0.1~6500.0s	0.1s	0	○

Function Code	Parameter Name	Setting Range	Minimum Unit	Default	Property
P6.41	Whether sleep frequency participates in hibernation selection (And sleep pressure percentage selection)	<b>Units: Sleep selection</b> 0: Sleep frequency condition is valid 1: Sleep frequency condition is invalid <b>Ten place: percentage</b> 0: Wake up and sleep pressure is the actual pressure; 1: Wake up and sleep pressure is a percentage of the set pressure	1	01	○
P6.42	Constant pressure water supply blockage judgment time	0.1s~600.0s	0.1s	60.0s	○
<b>Group P7: Operation Panel and Display</b>					
P7.00	REV key function selection	0: RVE key disabled 1: Switchover between operation panel control and remote command control (terminal or communication) 2: Switchover between forward rotation and reverse rotation 3: Forward JOG 4: Reverse JOG 5: Reverse	1	2	○
P7.01	STOP key function	0: STOP key enabled only in operation panel control 1: STOP key enabled in any operation mode	1	1	○
P7.02	LED display running parameters 1	0000~FFFF Bit00: Running frequency 1(Hz) Bit01: Set frequency (Hz) Bit02: Bus voltage(V) Bit03: Output voltage(V) Bit04: Output current(A) Bit05: Output power(KW) Bit06: Output torque (%)	1	001F	○

Function Code	Parameter Name	Setting Range	Minimum Unit	Default	Property
		Bit07:DI input status Bit08: Feedback pressure value Bit09:VI voltage(V) Bit10: CI voltage(V) Bit11: Given pressure value Bit12: Count value Bit13: Length value Bit14: Load speed display Bit15:PID setting			
P7.03	LED display running parameters 2	0000~FFFF Bit00:PID feedback Bit01:PLC stage Bit02:Pulse setting frequency (kHz) Bit03: Running frequency 2 (Hz) Bit04: Remaining running time Bit05:VI voltage before correction(V) Bit06:CI voltage before correction(V) Bit07:Reserve Bit08: Linear speed Bit09: Current power-on time (Hour) Bit10: Current running time (Min) Bit11: Pulse setting input frequency (kHz) Bit12: Communication setting value Bit13: Encoder feedback speed Bit14: Main frequency X display(Hz) Bit15: Auxiliary frequency Y display(Hz)	0.1	0000	○
P7.04	LED display stop parameters	0000~FFFF Bit00: Set frequency(Hz) Bit01: Bus voltage(V)	1	0033	○

Function Code	Parameter Name	Setting Range	Minimum Unit	Default	Property
		Bit02:DI input status Bit03:DO output status Bit04:VI voltage(V) Bit05:CI voltage(V) Bit06:Reserved Bit07: Count value Bit08: Length value Bit09:PLC stage Bit10: Load speed Bit11:PID setting Bit12:Pulse setting frequency (kHz)			
P7.05	Load speed display coefficient	0.0001~6.5000	0.0001	1.0000	○
P7.06	Heatsink temperature of inverter module	0.0°C~100.0°C	1	000	*
P7.07	Product number	0.00~10.00	0.01	-	*
P7.08	Accumulative running time	0H~65535h	1	000	*
P7.09	Software version 1	0.00~10.00	0.01	9000	*
P7.10	Software version 2	0.00~10.00	0.01	0.55	*
P7.11	Number of decimal places for load speed display	Unit's digit: B0-14 number of decimal places 0:0 decimal place 1:1 decimal place 2:2 decimal place 3:3 decimal place	1	1	○
P7.12	Accumulative power-on time	0~65535h	1	000	*
P7.13	Accumulative power consumption	0~65535kwh	0.1	0	*
<b>Group P8: Motor Parameters</b>					
P8.00	Motor type selection	0: Common asynchronous motor 1: Variable frequency asynchronous motor	1	0	×
P8.01	Rated motor power	0.1KW~1000.0KW	0.1KW	Model dependent	×
P8.02	Rated motor voltage	1V~2000V	1V	Model dependent	×
P8.03	Rated motor current	0.01A~655.35A( inverter	0.01A	Model	×



Function Code	Parameter Name	Setting Range	Minimum Unit	Default	Property
		power≤55KW) 0.1A~6553.5A(inverter power>55KW)		dependent	
P8.04	Rated motor frequency	0.01Hz to maximum frequency	0.01Hz	Model dependent	×
P8.05	Rated motor rotational speed	1rpm~65535rpm	1rpm	Model dependent	×
P8.06	Stator resistance (asynchronous motor)	0.001Ω~65.535Ω(inverter power≤55KW) 0.0001Ω~6.5535Ω(inverter power>55KW)	0.001Ω	Tuning parameter	×
P8.07	Rotor resistance (asynchronous motor)	0.001Ω~65.535Ω(inverter power≤55KW) 0.0001Ω~6.5535Ω(inverter power>55KW)	0.001Ω	Tuning parameter	×
P8.08	Leakage inductive reactance (asynchronous motor)	0.01mH~655.35mH(inverter power≤55KW) 0.001mH~65.535mH(inverter power>55KW)	0.01mH	Tuning parameter	×
P8.09	Mutual inductive reactance (asynchronous motor)	0.01mH~6553.5mH(inverter power≤55KW) 0.01mH~655.35mH(inverter power>55KW)	0.1mH	Tuning parameter	×
P8.10	No-load current (asynchronous motor)	0.01A~P8.03(inverter power≤55KW) 0.01A~P8.03(inverter power>55KW)	0.01	Tuning parameter	×
P8.16	PMSM stator resistance	0.001Ω ~ 65.535Ω (VFD≤55kw) 0.0001Ω ~ 6.5535Ω (VFD>55kW)	0.0001Ω	Auto tuning parameter	×
P8.17	PMSM D axis inductance	0.01mH ~ 655.35mH( VFD≤55kw) 0.001mH ~ 65.535mH( VFD>55kW)	0.01mH	Auto tuning parameter	×
P8.18	PMSM Q axis inductance	0.01mH ~ 655.35mH( VFD≤55kw) 0.001mH ~ 65.535mH( VFD>55kW)	0.01mH	Auto tuning parameter	×
P8.20	PMSM back EMF coefficient	0.1V ~ 6553.5V	0.1V	Auto tuning parameter	×
P8.27	Encoder pulses per	1~65535	1	1024	×

Function Code	Parameter Name	Setting Range	Minimum Unit	Default	Property
	revolution				
P8.28	Encoder type	0: ABZ incremental encoder 1: UVW incremental encoder 2: Rotary transformer 3: SIN/COS encoder 4: Wire-saving UVW encoder	1	0	×
P8.29	Reserved	-	-	-	-
P8.30	A,B phase sequence of ABZ incremental encoder	0: Forward 1: Reverse	1	0	×
P8.31	Encoder installation angle	0.0~359.9°	0.1°	1	×
P8.32	U,V,W phase sequence of UVW encoder	0: Forward 1: Reverse	1	0	×
P8.33	UVW encoder angle offset	0.0~359.9°	0.1°	0.0°	×
P8.34	Number of pole pairs of rotary transformer	1~65535	1	1	×
P8.37	Auto-tuning selection	0: no action 11: Static learning 12: Dynamic learning	1	0	×
<b>Group P9: Vector Control Parameters</b>					
P9.00	Speed/Torque control mode	0: Speed control 1: Torque control	1	0	×
P9.01	Speed loop proportional gain 1	1~100	1	30	○
P9.02	Speed loop integral time1	0.01s~10.00s	0.01s	0.50 s	○
P9.03	Switchover frequency 1	0.00~P9.06	0.01Hz	5.00Hz	○
P9.04	Speed loop proportional gain 2	1~100	1	20	○
P9.05	Speed loop integral time 2	0.01s~10.00s	0.01s	1.00s	○
P9.06	Switchover frequency 2	P9.02~to maximum output frequency	0.01Hz	10.00Hz	○
P9.07	Vector control slip gain	50%~200%	0.01%	100%	○
P9.08	Speed loop filtering	0.000s~0.100s	0.001s	28s	○

Function Code	Parameter Name	Setting Range	Minimum Unit	Default	Property
	time constant				
P9.09	Vector control over-excitation gain	0~200	1	64	○
P9.10	Torque upper limit source in speed control mode	0: P9.11 setting 1: VI 2: CI 4: Pulse setting 5: Communication setting 6: MIN(VI, CI) 7: MAX(VI, CI) 1~7 options' full range corresponds to P9.11	1	0	○
P9.11	Digital setting of torque upper limit in speed control mode	0.0%~200.0%	0.001	150.0%	○
P9.12	Torque upper limit source in speed control(stop) mode	0: Function code P9.12 setting 1: VI 2: CI 3: Reserved 4: Pulse setting 5: Communication setting 6: MIN(VI, CI) 7: MAX(VI, CI) Options 1~7 full range corresponds to P9.12	1	0	○
P9.13	Digital setting of torque upper limit in speed control(stop) mode	0.0%~200.0%	0.001	150.0%	○
P9.14	Excitation adjustment proportional gain	0~60000	1	2000	○
P9.15	Excitation adjustment integral gain	0~60000	1	1300	○
P9.16	Torque adjustment proportional gain	0~60000	1	2000	○
P9.17	Torque adjustment integral gain	0~60000	1	1300	○
P9.18	Speed loop integral property	Unit's digit: integral separation 0: Disabled	1	1	○

Function Code	Parameter Name	Setting Range	Minimum Unit	Default	Property
		1: Enabled			
P9.21	Over-modulation coefficient	100%~110%	100%	105%	×
P9.22	Max torque coefficient of excitation area	50%~200%	50%	100%	○
P9.24	Driving torque upper limit source	0: Digital setting1(P9.26) Below option range corresponds to drive torque upper limit (P9.26) 1: VI 2: CI 4: Pulse setting 5: Communication setting 6: MIN(VI, CI) 7: MAX(VI, CI)	1	0	×
P9.25	Reserved	-	-	-	*
P9.26	Digital setting of torque upper limit in torque control mode	-200.0%~200.0%	0.1%	150.0%	○
P9.27	Torque filter	-	-	-	*
P9.28	Maximum forward frequency in torque control mode	0.00Hz~maximum frequency	0.01Hz	50.00Hz	○
P9.29	Maximum reverse frequency in torque control mode	0.00Hz~maximum frequency	0.01Hz	50.00Hz	○
P9.30	Acceleration time of torque control	0.00s~65000s	0.01s	0.00s	○
P9.31	Deceleration time of torque control	0.00s~65000s	0.01s	0.00s	○
<b>Group PA: Fault and Protection</b>					
PA.00	Motor overload protection selection	0: Disabled 1: Enabled		1	○
PA.01	Motor overload protection gain	0.20~10.00		1.00	○
PA.02	Motor overload protection coefficient	50%~100%		80%	○
PA.03	Over voltage stall	0~100		0	○

Function Code	Parameter Name	Setting Range	Minimum Unit	Default	Property
	gain				
PA.04	Over voltage stall protective voltage	120%~150%		130%	○
PA.05	Over voltage stall gain	0~100		20	○
PA.06	Over voltage stall protective current	100%~200%		150%	○
PA.07	Short-circuit to ground upon power-on	0: Disabled 1: Enabled		1	○
PA.09	Fault auto reset times	0~20		0	○
PA.10	DO action during fault auto reset	0: Not act 1: Act		0	○
PA.11	Time interval of fault auto reset	0.1s~100.0s		1.0s	○
PA.12	Motor overload warning coefficient	Single digit: Enter the missing phase for protection selection. 0: Input phase loss protection is prohibited 1: Allow input phase loss protection ten digits: contactor suction protection option. 0: Pull-in is not protected 1: suction protection		11	○
PA.13	Output phase loss protection selection	0: Disabled 1: Enabled		1	○
PA.14	1st fault type	0: No fault 1: Over current during acceleration (E-01) 2: Over current during deceleration (E-02) 3: Over current at constant speed (E-03)	-	-	*

Function Code	Parameter Name	Setting Range	Minimum Unit	Default	Property
PA.15	2nd fault type	4: Over voltage during acceleration (E-04) 5: Over voltage during deceleration (E-05) 6: Over voltage at constant speed (E-06) 7: Contactor fault (E-07)	-	-	*
PA.16	3rd (latest) fault type	8: Inverter overheat (E-08) 9: Inverter overload (E-09) 10: Motor overload (E-10) 11: Under voltage (E-11) 12: output phase loss (E-12) 13: External equipment fault (E-13) 14: Current detection fault (E-14) 15: Communication fault (E-15) 16: System interference (E-16) 17: EEPROM read-write fault (E-17) 18: Motor auto-tuning fault (E-18) 19: Power input phase loss (E-19) 20: Short circuit to ground (E-20) 21: Encoder/PG card fault (E-21) 22: Buffer resistance overload fault (E-22) 23: Accumulative running time reached (E-23) 24: Accumulative power-on time reached (E-24) 25: Motor switchover fault during running (E-25) 26: With-wave current limit fault (E-26) 27: Motor overheat (E-27) 28: Too large speed deviation	-	-	*

Function Code	Parameter Name	Setting Range	Minimum Unit	Default	Property
		( E-28 ) 29: Motor over-load ( E-29 ) 30: Load becoming 0 ( E-30 ) 31: PID feedback lost during running ( E-31 ) 32: User defined fault 1 ( E-32 ) 33: User defined fault 2 ( E-33 ) 34: Contactor fault (E-34) 35: short-circuit to ground fault (E-35)			
PA.17	Frequency upon 3rd fault	-	-	-	*
PA.18	Current upon 3rd fault	-	-	-	*
PA.19	Bus voltage upon 3rd fault	-	-	-	*
PA.20	Input terminal status upon 3rd fault	-	-	-	*
PA.21	Output terminal status upon 3rd fault	-	-	-	*
PA.22	AC drive status upon 3rd fault	-	-	-	*
PA.23	Power-on time upon 3rd fault	-	-	-	*
PA.24	Running time upon 3rd fault	-	-	-	*
PA.25	Frequency upon 2nd fault	-	-	-	*
PA.26	Current upon 2nd fault	-	-	-	*
PA.27	Bus voltage upon 2nd fault	-	-	-	*
PA.28	Input terminal status upon 2nd fault	-	-	-	*
PA.29	Output terminal status upon 2nd fault	-	-	-	*
PA.30	AC drive status upon 2nd fault	-	-	-	*
PA.31	Power-on time	-	-	-	*

Function Code	Parameter Name	Setting Range	Minimum Unit	Default	Property
	upon 2nd fault				
PA.32	Running time upon 2nd fault	-	-	-	*
PA.33	Frequency upon 1st fault	-	-	-	*
PA.34	Current upon 1st fault	-	-	-	*
PA.35	Bus voltage upon 1st fault	-	-	-	*
PA.36	Input terminal status upon 1st fault	-	-	-	*
PA.37	Output terminal status upon 1st fault	-	-	-	*
PA.38	AC drive status upon 1st fault	-	-	-	*
PA.39	Power-on time upon 1st fault	-	-	-	*
PA.40	Running time upon 1st fault	-	-	-	*
PA.43	Fault protection action selection 1	Unit's digit: Motor overload (E-11) 0: Coast to stop 1: Stop according to the stop mode 2: Continue to run Ten's digit: Power output phase loss (E-12) Hundred's digit: External equipment fault(E-15) Thousand's digit: Communication fault (E-16) Ten thousand's digit: EEPROM read-write fault (E-17)	11111	00000	○
PA.44	Fault protection action selection 2	Unit's digit: Power input phase loss (E-19) 0: Coast to stop Ten's digit: Encoder fault (E-21) 0: Coast to stop 1: Stop according to the stop mode	11111	00000	○



Function Code	Parameter Name	Setting Range	Minimum Unit	Default	Property
		Hundred's digit: Accumulative running time reached Thousand's digit: Accumulative power-on time reached(E-24) Ten thousand's digit: Motor overheat (E-27)			
PA.45	Fault protection action selection 3	Unit's digit: Too large speed deviation (E-28) Ten's digit: Motor over-speed (E-29) Hundred's digit: Load becoming 0 (E-31) Thousand's digit: PID feedback lost during running (E-34) Ten thousand's digit: Reserved	11111	00000	○
PA.46	Fault protection action selection 4	Unit's digit: User-defined fault 1 (E-32) 0: Coast to stop 1: Stop according to the stop mode 2: Continue to run Ten's digit: User-defined fault 2 (E-33) Hundred's digit: Reserved	11111	00000	○
PA.50	Frequency selection for continuing to run upon fault	0: Current running frequency 1: Set frequency 2: Run Frequency upper limit 3: Run Frequency lower limit 4: Run Backup frequency upon abnormality	1	0	○
PA.51	Backup frequency upon abnormality	0.0%~100.0% (100.0% to maximum frequency)	0.001	100.0%	○
PA.53	Motor overheat protection threshold	0℃~200℃	1℃	110℃	○
PA.54	Motor overheat warning threshold	0℃~200℃	1℃	90℃	○
PA.55	Action selection at instantaneous	0: Invalid 1: Decelerate	1	0	○

Function Code	Parameter Name	Setting Range	Minimum Unit	Default	Property
	power failure	2: Deceleration to stop			
PA.56	Action pause judging voltage at instantaneous power failure	80.0%~100.0%	0.01Hz	90.0%	○
PA.57	Voltage rally judging time at instantaneous power failure	0.00s~100.00s	0.01s	0.50s	○
PA.58	Action judging voltage at instantaneous power failure	60.0%~100.0% (Standard bus voltage)	0.10%	80.0%	○
PA.59	Protection upon load becoming 0	0: Disabled 1: Enabled	1	0	○
PA.60	Detection level of load becoming 0	0.0~100.0%	0.001	10.0%	○
PA.61	Detection time of load becoming 0	0.0~60.0s	0.1s	1.0%	○
PA.63	Over-speed detection value	0.0%~50.0% (Maximum frequency)	0.1%	20.0%	○
PA.64	Over-speed detection time	0.0s:No detection 0.1~60.0s	0.001	1.0s	○
PA.65	Detection value of too large speed deviation	0.0%~50.0% (Maximum frequency)	0.1%	20.0%	○
PA.66	Detection time of too large speed deviation	0.0s: Not detected 0.1~60.0s	0.001	5.0s	○
<b>Group PB: Multi-Reference and Simple PLC Function</b>					
Pb.00	Multi-reference 0	-100.0% ~ 100.0%(100.0% to maximum frequency P0.05)	0	0.0%	○
Pb.01	Multi-reference 1	-100.0%~100.0%	0	0.0%	○
Pb.02	Multi-reference 2	-100.0%~100.0%	0	0.0%	○
Pb.03	Multi-reference 3	-100.0%~100.0%	0	0.0%	○
Pb.04	Multi-reference 4	-100.0%~100.0%	0	0.0%	○
Pb.05	Multi-reference 5	-100.0%~100.0%	0	0.0%	○
Pb.06	Multi-reference 6	-100.0%~100.0%	0	0.0%	○
Pb.07	Multi-reference 7	-100.0%~100.0%	0	0.0%	○
Pb.08	Multi-reference 8	-100.0%~100.0%	0	0.0%	○
Pb.09	Multi-reference 9	-100.0%~100.0%	0	0.0%	○
Pb.10	Multi-reference 10	-100.0%~100.0%	0	0.0%	○

Function Code	Parameter Name	Setting Range	Minimum Unit	Default	Property
Pb.11	Multi-reference 11	-100.0%~100.0%	0	0.0%	○
Pb.12	Multi-reference 12	-100.0%~100.0%	0	0.0%	○
Pb.13	Multi-reference 13	-100.0%~100.0%	0	0.0%	○
Pb.14	Multi-reference 14	-100.0%~100.0%	0	0.0%	○
Pb.15	Multi-reference 15	-100.0%~100.0%	0	0.0%	○
Pb.16	Simple PLC running mode	0: Stop after Inverter runs one cycle 1: Keep final values after inverter runs one cycle 2: Repeat after inverter runs one cycle	0	0	○
Pb.17	Simple PLC retentive selection	Unit's digit: Retentive upon power failure 0: NO retentive 1: YES Ten's digit: Retentive upon stop 0: NO 1: YES	0	00	○
Pb.18	Running time of simple PLC reference 0	0.0s(h)~6553.5s(h)	0	0.0s(h)	○
Pb.19	Deceleration time/direction of simple PLC reference 0	Units: time selection 0~3 Ten place: direction selection 0: forward 1: Reverse	0	0	○
Pb.20	Running time of simple PLC reference 1	0.0s(h)~6553.5s(h)	0	0.0s(h)	○
Pb.21	Deceleration time/direction of simple PLC reference 1	Units: time selection 0~3 Ten place: direction selection 0: forward 1: Reverse	0	0	○
Pb.22	Running time of simple PLC reference 2	0.0s(h)~6553.5s(h)	0	0.0s(h)	○
Pb.23	Deceleration time/direction of simple PLC	Units: time selection 0~3 Ten place: direction selection	0	0	○

Function Code	Parameter Name	Setting Range	Minimum Unit	Default	Property
	reference 2	0: forward 1: Reverse			
Pb.24	Running time of simple PLC reference 3	0.0s(h)~6553.5s(h)	0	0.0s(h)	○
Pb.25	Deceleration time/direction of simple PLC reference 3	Units: time selection 0~3 Ten place: direction selection 0: forward 1: Reverse	0	0	○
Pb.26	Running time of simple PLC reference 4	0.0s(h)~6553.5s(h)	0	0.0s(h)	○
Pb.27	Deceleration time/direction of simple PLC reference 4	Units: time selection 0~3 Ten place: direction selection 0: forward 1: Reverse	0	0	○
Pb.28	Running time of simple PLC reference 5	0.0s(h)~6553.5s(h)	0	0.0s(h)	○
Pb.29	Deceleration time/direction of simple PLC reference 5	Units: time selection 0~3 Ten place: direction selection 0: forward 1: Reverse	0	0	○
Pb.30	Running time of simple PLC reference 6	0.0s(h)~6553.5s(h)	0	0.0s(h)	○
Pb.31	Deceleration time/direction of simple PLC reference 6	Units: time selection 0~3 Ten place: direction selection 0: forward 1: Reverse	0	0	○
Pb.32	Running time of simple PLC reference 7	0.0s(h)~6553.5s(h)	0	0.0s(h)	○
Pb.33	Deceleration time/direction of simple PLC reference 7	Units: time selection 0~3 Ten place: direction selection 0: forward	0	0	○

Function Code	Parameter Name	Setting Range	Minimum Unit	Default	Property
		1: Reverse			
Pb.34	Running time of simple PLC reference 8	0.0s(h)~6553.5s(h)	0	0.0s(h)	○
Pb.35	Deceleration time/direction of simple PLC reference 8	Units: time selection 0~3 Ten place: direction selection 0: forward 1: Reverse	0	0	○
Pb.36	Running time of simple PLC reference 9	0.0s(h)~6553.5s(h)	0	0.0s(h)	○
Pb.37	Deceleration time/direction of simple PLC reference 9	Units: time selection 0~3 Ten place: direction selection 0: forward 1: Reverse	0	0	○
Pb.38	Running time of simple PLC reference 10	0.0s(h)~6553.5s(h)	0	0.0s(h)	○
Pb.39	Deceleration time/direction of simple PLC reference 10	Units: time selection 0~3 Ten place: direction selection 0: forward 1: Reverse	0	0	○
Pb.40	Running time of simple PLC reference 11	0.0s(h)~6553.5s(h)	0	0.0s(h)	○
Pb.41	Deceleration time/direction of simple PLC reference 11	Units: time selection 0~3 Ten place: direction selection 0: forward 1: Reverse	0	0	○
Pb.42	Running time of simple PLC reference 12	0.0s(h)~6553.5s(h)	0	0.0s(h)	○
Pb.43	Deceleration time/direction of simple PLC reference 12	Units: time selection 0~3 Ten place: direction selection 0: forward 1: Reverse	0	0	○

Function Code	Parameter Name	Setting Range	Minimum Unit	Default	Property
Pb.44	Running time of simple PLC reference 13	0.0s(h)~6553.5s(h)	0	0.0s(h)	○
Pb.45	Deceleration time/direction of simple PLC reference 13	Units: time selection 0~3 Ten place: direction selection 0: forward 1: Reverse	0	0	○
Pb.46	Running time of simple PLC reference 14	0.0s(h)~6553.5s(h)	0	0.0s(h)	○
Pb.47	Deceleration time/direction of simple PLC reference 14	Units: time selection 0~3 Ten place: direction selection 0: forward 1: Reverse	0	0	○
Pb.48	Running time of simple PLC reference 15	0.0s(h)~6553.5s(h)	0	0.0s(h)	○
Pb.49	Deceleration time/direction of simple PLC reference 15	Units: time selection 0~3 Ten place: direction selection 0: forward 1: Reverse	0	0	○
Pb.50	Time unit of simple PLC running	0: s(second) 1: H (hour)	0	0	○
Pb.51	Multi-reference 0 source	0: Set by PB.00 1: VI 2: CI 4:Pulse setting 5: PID 6: Set by preset frequency, modified via terminal UP/DOWN 7: Panel digital setting 2 (save when power off)	0	0	○
<b>Group PC: Communication Parameters</b>					
PC.00	Baud rate	MODBUS baud rate: 0: 300BPS 1: 600BPS 2: 1200BPS	1	5	○

Function Code	Parameter Name	Setting Range	Minimum Unit	Default	Property
		3: 2400BPS 4: 4800BPS 5: 9600BPS 6: 19200BPS 7: 38400BPS 8: 57600BPS 9: 115200BPS			
PC.01	Modbus data format	0: No check (8-N-2) 1: Even parity check (8-E-1) 2: Odd parity check (8-O-1) 3: No check (8-N-1) (Valid for MODBUS)	1	0	○
PC.02	Local address	0: Broadcast address 1~247 (Valid for MODBUS、Profibus-DP、CANlink)	1	1	○
PC.03	MODBUS Response delay	0~20ms(Valid for MODBUS)	1ms	2	○
PC.04	Serial port Communication timeout	0.0: Invalid 0.1: ~60.0s	0.1s	0.0	○
PC.05	Modbus protocol data format	MODBUS: 0: Non-standard Modbus protocol 1: Standard Modbus protocol	1	0	○
PC.06	Communication reading current resolution	0: 0.01A 1: 0.1A	0	0	○
<b>Group Pd: Function Code Management</b>					
Pd.00	User password	0~65535	1	0	○
Pd.01	Restore default setting	0: No operation 1: Restore factory setting, except motor parameters 2: Clear records	1	0	×
Pd.02	Inverter parameter display selection	Unit's digit: Group b display selection 0: Not display 1: Display Ten's digit: Group E display Selection 0: Not display 1: Display	1	001	×

Function Code	Parameter Name	Setting Range	Minimum Unit	Default	Property
Pd.03	Individualized parameter display selection	0、Display basic group; 1、Switchover to user-defined parameter display by press M 2、Switchover to user-modified parameter display by press M	1	0	○
Pd.04	Parameter modification property	0: Modifiable 1: Not modifiable	1	0	○
Pd.05	Second row digital LED display	Dual Display Valid	-	-	×
<b>Group PE: Swing Frequency, Fixed Length and Count</b>					
PE.00	Swing frequency setting mode	0: Relative to the central frequency 1: Relative to the maximum frequency	1	0	○
PE.01	Swing frequency amplitude	0.0%~100.0%	0.1%	0.0%	○
PE.02	Jump frequency amplitude	0.0%~50.0%	0.1%	0.0%	○
PE.03	Swing frequency cycle	0.1s~3000.0s	0.1s	10.0s	○
PE.04	Triangular wave rising time coefficient	0.1s~100.0%	0.1%	50.0%	○
PE.05	Set length	0m~65535m	1m	1000m	○
PE.06	Actual length	0m~65535m	1m	0m	○
PE.07	Number of pulse per meter	0.1~6553.5	0.1	100.0	○
PE.08	Set count value	1~65535	1	1000	○
PE.09	Designated count value	1~65535	1	1000	○
<b>Group PF: AIAO Correction and AI Curve Setting</b>					
PF.00	VI measured voltage 1	0.500V~4.000V	0.001V	2.000V	○
PF.01	VI sampling voltage 1	0.500V~4.000V	0.001V	2.000V	○
PF.02	VI measured voltage 2	6.000V~9.999V	0.001V	8.000V	○
PF.03	VI sampling voltage 2	6.000V~9.999V	0.001V	8.000V	○
PF.04	CI measured voltage 1	0.500V~4.000V	0.001V	2.000V	○
PF.05	CI sampling voltage 1	0.500V~4.000V	0.001V	2.000V	○



Function Code	Parameter Name	Setting Range	Minimum Unit	Default	Property
PF.06	CI measured voltage 2	6.000V~9.999V	0.001V	8.000V	○
PF.07	CI sampling voltage 2	6.000V~9.999V	0.001V	8.000V	○
PF.12	AO1 ideal voltage 1	0.500V~4.000V	0.001V	2.000V	○
PF.13	AO1 measured voltage 1	0.500V~4.000V	0.001V	2.000V	○
PF.14	AO1 ideal voltage 2	6.000V~9.999V	0.001V	8.000V	○
PF.15	AO1 measured voltage 2	6.000V~9.999V	0.001V	8.000V	○
PF.16	AO2 ideal voltage 1	0.500V~4.000V	0.001V	2.000V	○
PF.17	AO2 measured voltage 1	0.500V~4.000V	0.001V	2.000V	○
PF.18	AO2 ideal voltage 2	6.000V~9.999V	0.001V	8.000V	○
PF.19	AO2 measured voltage 2	6.000V~9.999V	0.001V	8.000V	○
PF.20	Curve 4 minimum input	-10.00V~PF.22	0.01V	0.00V	○
PF.21	Curve 4 minimum input corresponding setting	-100.0%~+100.0%	0.001	0.0%	○
PF.22	Curve 4 inflection point 1 input	PF.20~PF.22	0.01V	3.00V	○
PF.23	Curve 4 inflection point 1 input corresponding setting	-100.0%~+100.0%	0.001	30.0%	○
PF.24	Curve 4 inflection point 2 input	PF.22~PF.26	0.01V	6.00V	○
PF.25	Curve 4 inflection point 2 input corresponding setting	-100.0%~+100.0%	0.001	60.0%	○
PF.26	Curve 4 maximum input	PF.26~+10.00V	0.01V	10.00V	○
PF.27	Curve 4 maximum input corresponding setting	-100.0%~+100.0%	0.001	100.0%	○
PF.28	Curve 5 minimum input	-10.00V~PF.10	0.01V	0.01V	○
PF.29	Curve 5 minimum input corresponding setting	-100.0%~+100.0%	0.001	-100.0%	○

Function Code	Parameter Name	Setting Range	Minimum Unit	Default	Property
PF.30	Curve 5 inflection point 1 input	PF.28~PF.32	0.01V	-3.00V	○
PF.31	Curve 5 inflection point 1 input corresponding setting	-100.0%~+100.0%	0.001	-30.0%	○
PF.32	Curve 5 inflection point 2 input	PF.30~PF.34	0.01V	3.00V	○
PF.33	Curve 5 inflection point 2 input corresponding setting	-100.0%~+100.0%	0.001	30.0%	○
PF.34	Curve 5 maximum input	PF.32~+10.00V	0.01V	10.00V	○
PF.35	Curve 5 maximum input corresponding setting	-100.0%~+100.0%	0.001	100.0%	○
PF.36	VI set jump point	-100.0%~100.0%	0.001	0%	○
PF.37	VI set the jump range	0.0%~100.0%	0.001	0.5%	○
PF.38	CI set jump point	-100.0%~100.0%	0.001	0%	○
PF.39	CI set jump range	0.0%~100.0%	0.001	0.5%	○
<b>EF group User function code parameter group</b>					
EF.00	PMSM output voltage saturation margin	0%~50%	1%	5%	○
EF.01	PMSM initial position angle detection current	50%~180%	1%	80%	×
EF.02	PMSM initial position angle detection	0: detect every time running 1: no detection 2: detect one time once power on	1	0	○
EF.04	PMSM salient pole rate gain	50~500	1	100	○
EF.05	Maximum torque current ratio control	0~1	0	0	
EF.09	Z signal correction	0~1	1	1	×
EF.10	PMSM SVC initial magnetizing current limit value	0~80%	1%	30%	×
EF.11	PMSM SVC initial minimum carrier frequency	2~P0-15	0.1k	1.5k	×

Function Code	Parameter Name	Setting Range	Minimum Unit	Default	Property
<b>E6 Motor parameters</b>					
E6.00	Synchronous machine field weakening mode	Synchronous machine field weakening mode	1	0	×
E6.01	Synchronous motor field weakening coefficient	Synchronous motor field weakening coefficient	1	0	×
E6.02	Maximum field weakening current	Maximum field weakening current			
E6.03	Field weakening automatic tuning coefficient	Field weakening automatic tuning coefficient			
<b>E9 group protection function parameter group</b>					
E9.00	VF overcurrent operating current	50~200%	50%	150%	○
E9.01	VF over-speed enable	0: invalid 1: valid	1	1	○
E9.02	VF overrun speed suppression gain	0~100	1	20	○
E9.03	VF double speed over loss speed action current compensation coefficient	50~200%	50%	50%	○
E9.04	Overvoltage stall operating voltage	200.0V~2000.0V	200V	Model determination 220V: 380V 380V: 760V 480V: 850V 690V: 1250V 1140V:1900V	○
E9.05	VF overvoltage stall enable	0: invalid 1: valid	1	1	○
E9.06	VF overvoltage stall suppression frequency gain	0~100	1	30	○
E9.07	VF overvoltage stall suppression voltage gain	0~100	1	30	○
E9.08	Overvoltage stall	0~50Hz	0.1Hz	5Hz	×

Function Code	Parameter Name	Setting Range	Minimum Unit	Default	Property
	maximum rise limit frequency				
E9.09	Slip compensation time constant	0.1~10.0s	0.1s	0.5s	○
E9.18	Speed tracking closed loop current size	30%~200%	30%	Model determination	○
E9.21	Demagnetization time	0.0~5.0s	0.1s	Model determination	○
<b>B-Monitoring function parameters</b>					
b0.00	Operating frequency (Hz)	0.00Hz~P0.02Hz	0.01Hz	7000H	
b0.01	Set frequency (Hz)	0.00Hz~P0.02Hz	0.01Hz	7001H	
b0.02	Bus voltage (V)	0.0V~1000.0V	0.1V	7002H	
b0.03	Output voltage (V)	0V~380V	1V	7003H	
b0.04	Output current (A)	0.01A~655.35A	0.01A	7004H	
b0.05	Output power (KW)	0.0KW~1000.0KW	0.1KW	7005H	
b0.06	Output torque (%)	0.0%~200.0%	0.1%	7006H	
b0.07	DI input status	H.0000~H.FFFF	1	7007H	
b0.08	DO output status	H.0000~H.FFFF	1	7008H	
b0.09	V1 voltage (V)	0.00V~10.00V	0.01V	7009H	
b0.10	CI voltage (V) / current (MA)	0.00V ~ 10.00V	0.01V / 0.01MA	700AH	
b0.12	Count value	0~65535	1	700CH	
b0.13	Length value	0~65535	1	700DH	
b0.14	Load speed display	0.00Hz~P0.05Hz	1	700EH	
b0.15	PID setting	0~65535	1	700FH	
b0.16	PID feedback	0.00~300.00KHz	1	7010H	
b0.17	PLC stage	0~65535	1	7011H	
b0.18	PULSE input pulse frequency	0.00Hz~P0.05Hz	0.01KHz	7012H	
b0.19	Feedback speed (Hz)	0.00Hz~P0.05Hz	0.01Hz	7013H	
b0.20	Remaining running time	0~65535	0.1MIN	7014H	
b0.21	V1 pre-correction voltage	0.00V~10.00V	0.001V	7015H	
b0.22	C1 pre-correction voltage (V) /Current (MA)	0.00V~10.00V	0.001V/0.01 MA	7016H	

Function Code	Parameter Name	Setting Range	Minimum Unit	Default	Property
b0.24	Line speed	0 M/MIN ~65535 M/min	1M/ min	7018H	
b0.25	Current power-on time	0.0~6553.5	1min	7019H	
b0.26	Current running time	0.0~6553.5	0.1min	701AH	
b0.27	PULSE Input pulse frequency	0.0~300.0KHz	1Hz	701BH	
b0.28	Communication setting	0.00~100.00	0.01%	701CH	
b0.29	Encoder feedback speed	0.00Hz~P0.05Hz	0.01Hz	701DH	
b0.30	Main frequency X display	0.00Hz~P0.05Hz	0.01Hz	701EH	
b0.31	Auxiliary frequency Y display	0.00Hz~P0.05Hz	0.01Hz	701FH	
b0.32	View any memory address value	-	1	7020H	
b0.34	Motor temperature	0.0~6553.5	1℃	7022H	
b0.35	value Target torque (%)	0.0~6553.5	0.1%	7023H	
b0.36	Rotational position	0.0~6553.5	1	7024H	
b0.37	Power factor angle	0.00~100.00	0.1°	7025H	
b0.38	ABZ position	0.00Hz~P0.05Hz	1	7026H	
b0.39	VF separation target voltage	0V~380V	1V	7027H	
b0.40	VF separation output voltage	0V~380V	1V	7028H	
b0.41	DI input status visual display	-	1	7029H	
b0.42	Visualization of DO input status	-	1	702AH	
b0.43	DI function status visual display 1 (function 01 - function 40)	-	1	702BH	
b0.44	DI function status visual display 2 (function 41 - function 80)	-	1	702CH	
b0.46	Set pressure	-	1	-	
b0.47	Feedback pressure	-	1	-	

---

## Chapter 6 Detailed Function Parameter Description

### Group P0: Standard Function Parameter

Function Code	Parameter Name	Setting Range	Minimum Unit	Default	Property
P0.00	Control mode	0~2	1	0	×

#### 0: V/F control

It is suitable for applications where the load requirements are not high, or when one inverter drives multiple motors, such as fans and pumps. It can be used in the case where one inverter drives multiple motors.

#### 1: no speed sensor vector control

Refers to open-loop vector control, suitable for general high-performance control applications, one inverter can only drive one motor. Such as machine tools, centrifuges, wire drawing machines, injection molding machines and other loads.

#### 2: Speed sensor vector control

Refers to the closed-loop vector control, the motor must be equipped with an encoder, the inverter must be equipped with the same type of expansion card as the encoder, suitable for high-precision speed control or torque control. Only one motor can be driven by one inverter. Such as high-speed paper machinery, lifting machinery, elevators and other loads.

Function Code	Parameter Name	Setting Range	Minimum Unit	Default	Property
P0.00	Main frequency source 1 selection	0~9	1	0	×

#### 0: Digital setting 1(P0.02, UP/DOWN can modify, non-retentive at power failure)

Use the keyboard's ▲, ▼, keys or knob switch to set the operating frequency. When the inverter is powered off and powered up again, the set frequency value returns to the value of P0.02 “Digital Set Preset Frequency”.

#### 1: Digital setting 2(P0.02, UP/DOWN can modify, retentive at power failure)

Operate the keyboard keys or knob switches to set the operating frequency. When the inverter is powered off and then powered on again, the set frequency is the set frequency at the time of the last power-down, and is corrected by the ▲, ▼ keys or the correction amounts of the terminals UP and DOWN.

---

## **2: VI analog setting (VI-GND)**

The frequency setting is determined by the analog voltage of the VI terminal. The input voltage range is DC 0~10V. The correspondence between frequency and VI input is determined by function code P3.21~P3.24.

## **3: CI analog setting (CI-GND)**

The frequency setting is determined by the CI terminal analog voltage/current. The input range is DC 0~10V (J8 jumper selects V side), DC: 4~20mA (J8 jumper selects A side). The correspondence between frequency and CI input is determined by function code P3.21~P3.24.

## **5: Pulse setting**

The frequency setting is determined by the terminal pulse frequency (the pulse signal can only be input by X5). The correspondence between frequency and PLUSE input is determined by function code P3.31~P3.34.

## **6: Multi-reference**

Different combinations of states of the digital input DI terminals correspond to different set frequency values. NE900 can set 4 multi-segment command terminals (terminal functions 12~15), 16 states of 4 terminals, can correspond to any 16 "multi-segment commands" through FC group function code, "multi-segment command" is relative maximum frequency P0.05 Percentage. When the digital input DI terminal is used as the multi-segment command terminal function, it needs to be set in the P3 group. For details, please refer to the related function parameter description of the P3 group.

## **7: Simple PLC**

When the frequency source is a simple PLC, the running frequency source of the inverter can be switched between 1~16 arbitrary frequency commands. The holding time of 1~16 frequency commands and the respective acceleration/deceleration time can also be set by the user. Description of the Pb group.

## **8: PID**

When applying PID as the frequency source, you need to set the P6 function "PID function" related parameters.

## **9: 485 communication**

The frequency is given by the communication method. The upper computer gives the data by the communication address 0x1000, the data format is -100.00%~100.00%, and 100.00%

refers to the percentage of the relative maximum frequency P0.05.

Function Code	Parameter Name	Setting Range	Minimum Unit	Default	Property
P0.02	Setting running frequency	P0.07lower limit frequency~ P0.06 upper limit frequency	0.01Hz	50.00Hz	○

When the frequency setting channel is defined as a digital setting (P0.01=1, 2), the P0.02 parameter is the original set frequency of the inverter.

Function Code	Parameter Name	Setting Range	Minimum Unit	Default	Property
P0.03	Command source selection	0~2	1	0	○

#### 0: Operation panel control (LED off)

Use the operating keyboard FWD, STOP/RESET, JOG to start and stop.

#### 1: Terminal control (LED on)

Start and stop with external control terminals FWD, REV, X1 to X6, etc.

#### 2: Communication control (LED blinking)

Use the RS485 interface to control start and stop.

Function Code	Parameter Name	Setting Range	Minimum Unit	Default	Property
P0.04	Running direction setting	0~1	1	0	○

#### 0: Same direction

Use the operating keyboard FWD, STOP/RESET, JOG to start and stop.

#### 1: Reverse direction

Start and stop with external control terminals FWD, REV, X1 to X6, etc.

**Note:** After the parameters are initialized, the motor running direction will return to the original state. Be careful not to change the direction of the motor after the system is debugged.

Function Code	Parameter Name	Setting Range	Minimum Unit	Default	Property
P0.05	Maximum frequency	50.00Hz~5000.00Hz	0.01Hz	50.00Hz	×



In the NE900, the analog input, pulse input (X5), multi-segment command, etc., as the frequency source, each 100.0% is scaled relative to P0.05.

Function Code	Parameter Name	Setting Range	Minimum Unit	Default	Property
P0.06	Frequency upper limit	Frequency lower limit to maximum frequency (P0.05)	0.01Hz	50.00Hz	○
P0.07	Frequency lower limit	0.00Hz to frequency upper limit(P0.06)	0.01Hz	0.00Hz	○
P0.08	Source of frequency upper limit	0-5	1	0	×

Define the source of the upper limit frequency. The upper frequency source can be selected:

**0: Set by P0.02;**

**1: V1;**

**2: CI;**

**3: ----;**

**4: X5 PULSE setting;**

**5: Communication setting.**

When using analog setting, PULSE setting (X5) or communication setting, it is similar to the main frequency source, see P0.01.

Function Code	Parameter Name	Setting Range	Minimum Unit	Default	Property
P0.09	Frequency upper limit offset	0.00Hz to maximum frequency (P0.05)	0.01Hz	0.00Hz	○

When the upper limit frequency is analog or PULSE, P0.09 is used as the offset of the set value, and the offset frequency is superimposed with the upper limit frequency value of P0.08 as the set value of the final upper limit frequency.

Function Code	Parameter Name	Setting Range	Minimum Unit	Default	Property
P0.10	Carrier frequency	0.5KHz~16.0KHz	0.01Hz	Model setting	○

The carrier frequency primarily affects motor noise and heat loss during operation. The relationship between carrier frequency and motor noise, leakage current, and interference is as follows:

Carrier frequency	Reduce	Raise
Electromagnetic noise	↑	↓

Carrier frequency	Reduce	Raise
Leakage current	↓	↑
interference	↓	↑

**Prompt:**

- In order to obtain better control characteristics, the ratio of the carrier frequency to the maximum operating frequency of the inverter is recommended not to be lower than 36.
- When the carrier frequency is low, there is an error in the current display value.

Function Code	Parameter Name	Setting Range	Minimum Unit	Default	Property
P0.11	Carrier frequency adjustment with temperature	0~1	1	0	○

**1:No**

**2: Yes**

The carrier frequency is adjusted with temperature, which means that when the driver detects that the temperature of the radiator is high, the carrier frequency is automatically reduced to reduce the temperature rise of the driver. When the heat sink temperature is low, the carrier frequency gradually returns to the set value. This feature reduces the chance of a drive overheating alarm.

Function Code	Parameter Name	Setting Range	Minimum Unit	Default	Property
P0.12	Acceleration time 0	0.1~6000.0s	0.1s	Model setting	○
P0.13	Deceleration time 0	0.1~6000.0s	0.1s	Model setting	○

Acceleration/deceleration time refers to the time required for the inverter to accelerate from zero frequency to the maximum frequency (P0.05) (t1 in Figure 6-1) and the time required to decelerate from the maximum frequency (P0.05) to 0 frequency. (t2 in Figure 6-1).

The NE900 inverter provides 4 sets of acceleration/deceleration time. The user can use the digital input terminal DI to switch the selection. The four groups of acceleration/deceleration time are set by the following function codes:

The first group: P0.12~ P0.13;

The second group: P2.03~ P2.04;

The third group: P2.05~ P2.06;

The fourth group: P2.07~ P2.08.

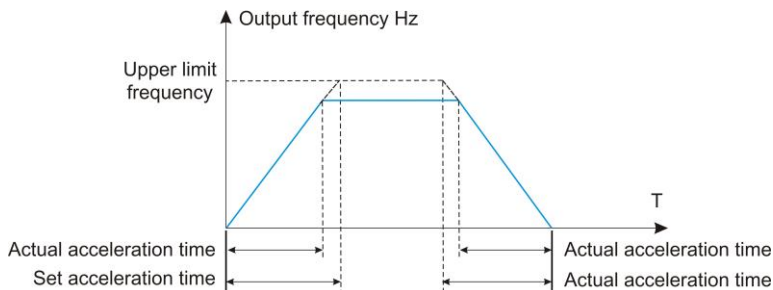

Fig. 6-1 Acceleration/Deceleration time

Function Code	Parameter Name	Setting Range	Minimum Unit	Default	Property
P0.14	Acceleration/ Deceleration time unit	0~2	1	1	×

0: 1s

1: 0.1s

2: 0.01s

Prompt:

- When modifying the function parameters, the number of decimal points displayed in the 4 groups of acceleration/deceleration time will change, and the corresponding acceleration/deceleration time will also change. Pay special attention during the application process.

Function Code	Parameter Name	Setting Range	Minimum Unit	Default	Property
P0.15	Acceleration/ Deceleration time base frequency	0~3	1	0	×

0: maximum frequency (P0.05)

1: set frequency

2: 100.00Hz

3: Basic frequency of motor

Function Code	Parameter Name	Setting Range	Minimum Unit	Default	Property
P0.16	Auxiliary frequency source 2 selection	The same as P0.01(Main frequency source 1 selection)	1	0	×

The auxiliary frequency reference mode is consistent with the main frequency reference mode. Refer to the P0.01 function code description for details.

Function Code	Parameter Name	Setting Range	Minimum Unit	Default	Property
P0.17	Basic value of auxiliary frequency when overlay	0~1	1	0	○

**0: Relative to maximum frequency**

**1: Relative to main frequency**

Function Code	Parameter Name	Setting Range	Minimum Unit	Default	Property
P0.18	Range of auxiliary frequency 2 for 1 and 2 operation	0%-150%	0%	100%	○

This parameter is used to determine the adjustment range of the auxiliary frequency source.

**Prompt:**

- If selected to be relative to the primary frequency, the range of the secondary frequency source will vary as the primary frequency is given.

Function Code	Parameter Name	Setting Range	Minimum Unit	Default	Property
P0.19	Frequency source overlay selection	11-00	01	00	○

**Unit digits: frequency source selection**

0: Main frequency source 1;

1: Main and Aux operation (operation relationship determined by ten's digit);

2: Switchover between main source 1 and Aux source 2; It can be controlled by multi-function terminal 18 (frequency reference switching). When the multi-function input terminal function 18 is invalid, the main reference mode (P0.01) is used as the target frequency;

When the multi-function input terminal function 18 is valid, the auxiliary reference mode (P0.19) is used as the target frequency;

3: Switchover between main source 1 and operation result of Main+Aux :function switching through multi-function terminal 18;

---

4: Switchover between source 2 and operation result of Main+Aux Ten's digit (Main & Aux frequency operation relationship): function switching through multi-function terminal 18.

### Ten digits: frequency source primary and secondary operation relationship

0: Main+Aux;

1: Main - Aux;

2: Maximum value of Main&Aux;

3: Minimum value of Main & Aux.

Function Code	Parameter Name	Setting Range	Minimum Unit	Default	Property
P0.20	Frequency offset of auxiliary frequency source for 1 and 2 operation(overlay)	0.00Hz to maximum frequency (P0.05)	0.01Hz	0.00Hz	○

This function code is valid only when the frequency source is selected as the main and auxiliary operation. When the frequency source is the main auxiliary operation, P0.20 is the offset frequency, and the result of the main and auxiliary operations is superimposed as the final frequency setting, so that the frequency setting can be more flexible.

Function Code	Parameter Name	Setting Range	Minimum Unit	Default	Property
P0.21	Frequency command resolution	1~2	1	2	○

**1: 0.1Hz**

**2: 0.01Hz**

#### Prompt:

- When the system frequency decimal point changes, pay attention to changing the maximum frequency (P0.05 and upper limit frequency P0.06).

Function Code	Parameter Name	Setting Range	Minimum Unit	Default	Property
P0.22	Digital setting frequency memory selection	0~1	1	0	○

Units: This function is only available when the frequency source is digitally set.

#### 0: Not retentive

After the inverter stops, the digital set frequency value returns to the value of P0.02 (preset

---

frequency), and the frequency correction performed by the keyboard, key or terminals UP and DOWN is cleared.

### 1: Retentive

After the inverter is stopped, the digital set frequency remains the set frequency of the last stop time, and the frequency correction performed by the keyboard, key or terminals UP and DOWN remains valid.

Tens place: memory selection when PB51 is pre-made frequency

**0: no memory**

**1: Memory**

Function Code	Parameter Name	Setting Range	Minimum Unit	Default	Property
P0.23	Modification during running Base frequency for UP/DOWN	0~1	1	0	×

### 0: Running frequency

#### 1: Set frequency

This parameter is valid only when the frequency source is digitally set. When determining the keyboard or terminal UP/DOWN action, what method is used to correct the set frequency, that is, whether the target frequency is increased or decreased based on the operating frequency or increased or decreased based on the set frequency.

Function Code	Parameter Name	Setting Range	Minimum Unit	Default	Property
P0.24	Binding command source to frequency source	0000~9999	0001	0000	×

### 0: Running frequency

#### 1: Set frequency

This parameter is valid only when the frequency source is digitally set. When determining the keyboard or terminal UP/DOWN action, what method is used to correct the set frequency, that is, whether the target frequency is increased or decreased based on the operating frequency or increased or decreased based on the set frequency.

Command channel and frequency reference channel relationship setting	
LED unit	Control panel command binding frequency source
LED ten	Terminal command channel binding frequency source
LED hundred	Communication command channel binding frequency source
LED thousand	Automatically run the binding frequency source

The function code defines a bundle combination of four running command channels and nine frequency given channels, so that different running command channels are bundled with different frequency given. The meaning of each bit is the same as the frequency main setting mode P0.01. Please refer to the P0.01 function code description.

When the command source has a bundled frequency source, the main frequency (P0.02), the auxiliary frequency reference (P0.16), and the frequency channel superposition selection (P0.19) are invalid during the valid period of the command source.

Function Code	Parameter Name	Setting Range	Minimum Unit	Default	Property
P0.25	G/P type setting	1~2	1	Model determination	*

**1: Constant torque load for specified rated parameters**

**2: Variable torque load (fan, pump load) for specified rated parameters**

Function Code	Parameter Name	Setting Range	Minimum Unit	Default	Property
P0.27	Serial communication protocol	0	1	0	x

NE900 uses serial port to achieve 0: MODBUS protocol.

---

## Group P1: Start/Stop Parameter

Function Code	Parameter Name	Setting Range	Minimum Unit	Default	Property
P1.00	Start mode	0~2	1	0	○

### 0: Direct start

When the inverter starts running from the stop state, if P1.02 and P1.03 are set, the DC braking starts from the starting frequency (P1.01) and maintains the time set by P1.02 at this frequency. Then, press the set acceleration mode and acceleration time to run to the set frequency. Otherwise there is no DC braking process.

### 1: Rotational speed tracking restart

The actual speed of the motor being rotated is searched first, and a smooth start without impact is started from the searched speed. It is suitable for applications such as instantaneous power failure and restart, starting the fan that is still rotating. To ensure the accuracy of the speed search, please set the motor parameters and P1.11~P1.12 parameters correctly.

### 2: Pre-excitation start

Only valid for asynchronous motors, used to establish a magnetic field before the motor is running.

Pre-excitation current and pre-excitation time are described in function codes P1.03 and P1.04.

If the pre-excitation time is set to 0, the inverter cancels the pre-excitation process and starts from the start frequency. If the pre-excitation time is not 0, the pre-excitation is restarted first, which can improve the dynamic response performance of the motor.

Function Code	Parameter Name	Setting Range	Minimum Unit	Default	Property
P1.01	Startup frequency	0.00~10.00Hz	0.01Hz	0.00Hz	○
P1.02	Startup frequency holding time	0.0~100.0s	0.1s	0.0s	×

To ensure the motor torque at start-up, set the appropriate starting frequency. In order to fully establish the magnetic flux when starting the motor, the starting frequency needs to be maintained for a certain period of time.



Function Code	Parameter Name	Setting Range	Minimum Unit	Default	Property
P1.03	Startup DC braking current/ Pre-excited current	0%~100%	1%	0%	×
P1.04	Startup DC braking time/ Pre-excited time	0.0~100.0s	0.1s	0.0s	×

Start DC braking, generally used to stop the running motor and then start. Pre-excitation is used to make the asynchronous motor establish a magnetic field before starting, which improves the response speed.

Starting DC braking is only valid when the start mode is direct start (P1.00 is set to 0). At this time, the inverter first performs DC braking according to the set starting DC braking current, and then starts running after the DC braking time is started. If the DC braking time is set to 0, it will start directly without DC braking. The greater the DC braking current, the greater the braking force. If the starting mode is asynchronous machine pre-excitation start (P1.00 is set to 1), the inverter first establishes the magnetic field according to the set pre-excitation current, and then starts running after the set pre-excitation time. If the pre-excitation time is set to 0, it will start directly without the pre-excitation process.

#### Prompt:

- Start DC braking current / pre-excitation current, which is a percentage of the rated current of the inverter.

Function Code	Parameter Name	Setting Range	Minimum Unit	Default	Property
P1.05	Stop mode	0: Decelerate to stop 1: Natural stop	1	0	○

#### 0: Decelerate to stop

After the inverter receives the stop command, the output frequency is gradually reduced according to the set deceleration time, and the frequency is reduced to zero and then stopped.

#### 1: Natural stop

After the inverter receives the stop command, it immediately terminates the output, and the motor stops freely according to the mechanical inertia.

Function Code	Parameter Name	Setting Range	Minimum Unit	Default	Property
P1.06	Initial frequency of stop DC braking	0.00Hz to maximum frequency	0.00Hz	0.00Hz	○

Function Code	Parameter Name	Setting Range	Minimum Unit	Default	Property
P1.07	Waiting time of stop DC braking	0.0~100.0s	0.1s	0.0s	○
P1.08	DC braking time when stop	0.0~100.0s	0.1s	0.0s	○
P1.09	DC braking Current when stop	0%~100%	1%	0%	○

P1.06: DC braking is started when the running frequency is reduced to this frequency during the deceleration stop.

P1.07: After the running frequency is reduced to the stop DC braking start frequency, the inverter stops output for a period of time before starting the DC braking process. It is used to prevent malfunctions such as overcurrent that may be caused by starting DC braking at higher speeds.

P1.08: Refers to the output current during DC braking, as a percentage of the rated motor current. The larger the value, the stronger the DC braking effect, but the greater the heat generated by the motor and the inverter.

P1.09: The time during which the DC braking amount is maintained. This value is 0 and the DC braking process is cancelled. The specific shutdown DC braking is described in Figure6-2.

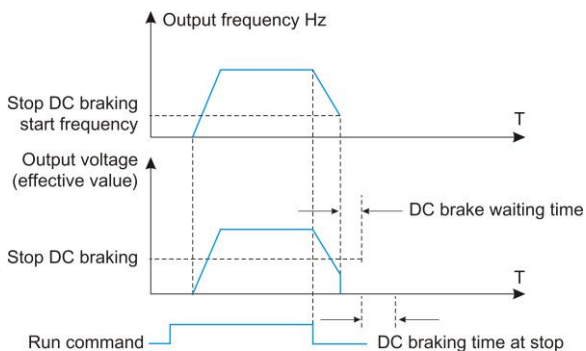

Fig. 6-02 Stop DC braking process

Function Code	Parameter Name	Setting Range	Minimum Unit	Default	Property
P1.10	Braking unit use ratio	0%~100%	1%	100%	○

It is used to adjust the duty ratio of the brake unit. When the brake usage rate is high, the duty ratio of the brake unit is high and the braking effect is strong. However, the voltage of the inverter bus voltage fluctuates greatly during the braking process.

Function Code	Parameter Name	Setting Range	Minimum Unit	Default	Property
P1.11	Rotational speed tracking mode	0~2	1	0	×

#### Speed tracking method:

0: Track down from the frequency at power failure. This method is usually used.

1: Start tracking from zero frequency, and use it when the power failure time is long and then restart.

2: Tracking from the maximum frequency, generally used for generating loads.

Function Code	Parameter Name	Setting Range	Minimum Unit	Default	Property
P1.12	Rotational speed tracking speed	1~100	1	20	○

When the speed tracking is restarted, the efficiency of the speed tracking is selected. The larger the parameter, the faster the tracking speed. However, setting too large may cause the tracking effect to be unreliable.

Function Code	Parameter Name	Setting Range	Minimum Unit	Default	Property
P1.13	Acceleration/ Deceleration mode	0~1	1	0	×

#### 0: Linear acceleration/ deceleration

The output frequency is incremented or decremented by a constant slope, as shown in Figure 6-3.

#### 1: S-curve acceleration/deceleration

The output frequency is incremented or decremented according to the S-shaped curve, as shown in Figure 6-4.

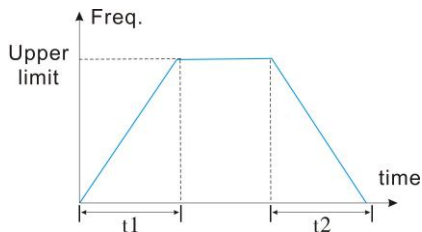

Fig. 6-03 Linear acceleration and deceleration

Function Code	Parameter Name	Setting Range	Minimum Unit	Default	Property
P1.14	Time proportion of S-curve start segment	0.0%~ (100.0%~ P1.15)	0.1%	30.0%	×
P1.15	Time proportion of S-curve end segment	0.0%~ (100.0%~ P1.14)	0.1%	30.0%	×

P1.14 and P1.15 are valid only when the S-curve acceleration/deceleration mode (P1.13=1) is selected for the acceleration/deceleration mode, and  $P1.14+P1.15 \leq 90\%$ .

The starting time of the S curve is shown as 3 in Figure 6-4, and the slope of the output frequency changes gradually from 0.

The rising period of the S curve is shown as 2 in Figure 6-4, and the slope of the output frequency change is constant.

The end time of the S curve is shown as 1 in Figure 6-4, and the slope of the output frequency change gradually decreases to zero.

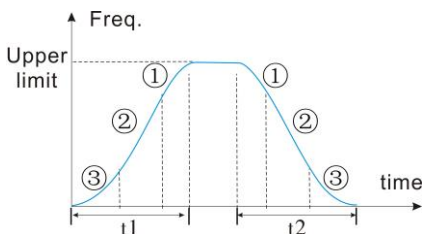

Fig. 6-04 S curve acceleration and deceleration

### Prompt:

- S-curve acceleration and deceleration mode, suitable for starting and stopping of elevators, conveyor belts, and transporting transmission loads.

## Group P2: Auxiliary Functions

Function Code	Parameter Name	Setting Range	Minimum Unit	Default	Property
P2.00	JOG running frequency	0.10 Hz to maximum frequency	0.01Hz	5.00Hz	○
P2.01	JOG acceleration time	0.1~6500.0s	0.1s	Model dependent	○
P2.02	JOG deceleration time	0.1~6500.0s	0.1s	Model dependent	○

The jog acceleration time refers to the time required for the inverter to accelerate from zero frequency to the upper limit frequency. The jog deceleration time refers to the time required for the inverter to reduce from the upper limit frequency to zero frequency.

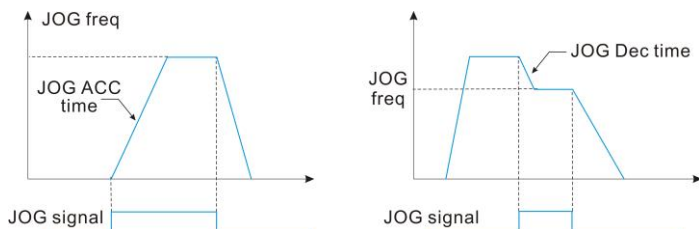

Fig. 6-05 JOG operation

Function Code	Parameter Name	Setting Range	Minimum Unit	Default	Property
P2.03	Acceleration time 1	0.1~6500.0s	0.1	Model dependent	○
P2.04	Deceleration time 1	0.1~6500.0s	0.1	Model dependent	○
P2.05	Acceleration time 2	0.1~6500.0s	0.1	Model dependent	○
P2.06	Deceleration time 2	0.1~6500.0s	0.1	Model dependent	○

Function Code	Parameter Name	Setting Range	Minimum Unit	Default	Property
P2.07	Acceleration time 3	0.1~6500.0s	0.1	Model dependent	○
P2.08	Deceleration time 3	0.1~6500.0s	0.1	Model dependent	○

Four kinds of acceleration/deceleration time can be defined, and the acceleration/deceleration time 1~4 during the running of the inverter can be selected by different combinations of control terminals. Please refer to the definition of the function of the acceleration/deceleration time terminal in P3.00~P3.09. In addition, the acceleration/deceleration time 1 is defined in P0.12 and P0.13 function codes.

Function Code	Parameter Name	Setting Range	Minimum Unit	Default	Property
P2.09	Jump frequency 1	0.0Hz to maximum frequency	0.01Hz	0.00Hz	○
P2.10	Jump frequency 2	0.0Hz to maximum frequency	0.01Hz	0.00Hz	○
P2.11	Jump frequency amplitude	0.0Hz to maximum frequency	0.01Hz	0.00Hz	○

P2.09~ P2.11 are functions for setting the output frequency of the inverter to avoid the resonance frequency point of the mechanical load. The set frequency of the inverter can be jumped around certain frequency points according to the way of Figure 6-6. Up to 2 jump ranges can be defined.

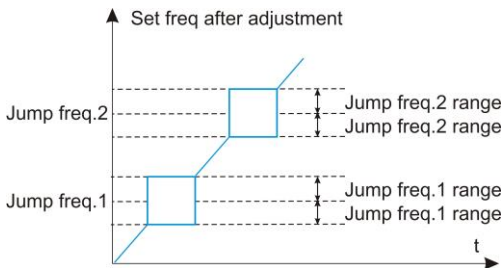

Fig. 6-06 Jump frequency and range

Function Code	Parameter Name	Setting Range	Minimum Unit	Default	Property
P2.12	Forward/Reverse rotation dead-zone time	0.0s~3000.0s	0.1s	0.0s	○

The transition time that the inverter waits from the forward running to the reverse running, or from the reverse running to the forward running, waiting at the output zero frequency, as t1 shown in Figure 6-7.

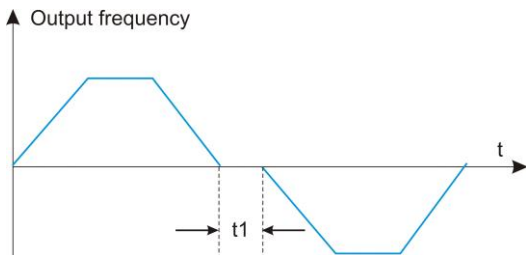

Fig. 6-07 Positive/reverse dead time

Function Code	Parameter Name	Setting Range	Minimum Unit	Default	Property
P2.13	Reverse control	0~1	0	0	○

This parameter is used to set whether the inverter is allowed to run in the reverse state. When the motor is not allowed to reverse, this parameter can be set to 1.

Function Code	Parameter Name	Setting Range	Minimum Unit	Default	Property
P2.14	Running mode when set frequency lower than frequency lower limit	0~2	0	0	○

**0: Run at frequency lower limit**

**1: Stop**

**2: Run at zero speed**

Function Code	Parameter Name	Setting Range	Minimum Unit	Default	Property
P2.15	Drop control	0.00Hz~10.00Hz	0.01Hz	0.00Hz	○

The function is generally used for load distribution when multiple motors are dragging the same load.

The droop control means that as the load increases, the output frequency of the inverter decreases, so that when multiple motors are dragged by the same load, the output frequency

---

of the motor in the load drops more, thereby reducing the load of the motor and realizing the operation of multiple motors. The load is even.

This parameter refers to the frequency drop value of the output when the inverter outputs the rated load.

Function Code	Parameter Name	Setting Range	Minimum Unit	Default	Property
P2.16	Accumulative power-on time threshold	0h~65000h	1h	0h	○

When the accumulated power-on time (P7.12) reaches the power-on time set by P2.16, the inverter multi-function digital DO outputs an ON signal.

Function Code	Parameter Name	Setting Range	Minimum Unit	Default	Property
P2.17	Accumulative running time threshold	0h~65000h	1h	0h	○

When the accumulated power-on time (P7.12) reaches the power-on time set by P2.16, the inverter multi-function digital DO outputs an ON signal.

Function Code	Parameter Name	Setting Range	Minimum Unit	Default	Property
P2.18	Startup protection	0~1	1	0	○

**0: NO**

**1: YES**

This parameter relates to the safety protection function of the frequency converter. If the parameter is set to 1, if the running command of the inverter is valid (for example, the terminal running command is closed before power-on), the inverter does not respond to the running command, and the running command must be removed once. After the running command is valid again. The inverter responds.

In addition, if the parameter is set to 1, if the running command of the inverter fault reset time is valid, the inverter does not respond to the running command, and the running command must be removed before the running protection state can be eliminated.

Setting this parameter to 1 can prevent the danger caused by the motor responding to the running command when the power is turned on or when the fault is reset without knowing it.



Function Code	Parameter Name	Setting Range	Minimum Unit	Default	Property
P2.19	Frequency detection value (FDT1)	0.00Hz to maximum frequency	0.01Hz	50.00Hz	○
P2.20	Frequency detection hysteresis (FDT1 level)	0.0%~100.0%(FDT1 level)	0.1%	5.0%	○

When the running frequency is higher than the frequency detection value, the multi-function output DO of the inverter outputs ON signal, and after the frequency is lower than the certain frequency value of the detected value, the DO output ON signal is canceled. The above parameters are used to set the detection value of the output frequency and the hysteresis value of the output action release. Where Pd.20 is the percentage of the hysteresis frequency relative to the frequency detection value Pd.19.

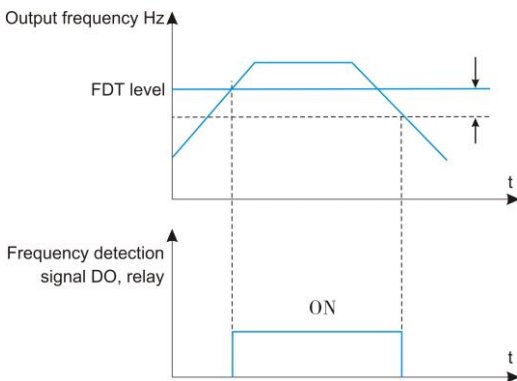

Fig. 6-08 FDT function

Function Code	Parameter Name	Setting Range	Minimum Unit	Default	Property
P2.21	Detection range of frequency reached	0.0%~100.0% ( maximum frequency)	0.1%	0.0%	○

When the running frequency of the inverter is within a certain range of the target frequency, the inverter multi-function DO outputs ON signal. This parameter is used to set the detection range of the frequency arrival, which is a percentage relative to the maximum frequency.

Figure 6-9 is a schematic diagram of frequency arrival.

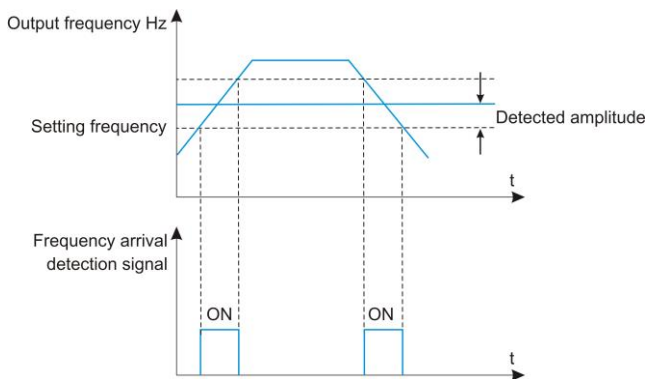

Fig. 6-09 Frequency arrival detection amplitude

Function Code	Parameter Name	Setting Range	Minimum Unit	Default	Property
P2.22	Jump frequency during acceleration /deceleration	0~1	1	0	○

**0: Disabled**

**1: Enabled**

This function code is used to set whether the skip frequency is valid during acceleration and deceleration.

When set to valid, when the running frequency is in the skip frequency range, the actual running frequency will skip the set skip frequency boundary.

Figure 6-10 shows the effective hopping frequency during acceleration and deceleration.

The NE900 provides two sets of arbitrary arrival frequency detection parameters, and sets the frequency value and frequency detection range respectively. Figure 6-11 shows a schematic of this function.

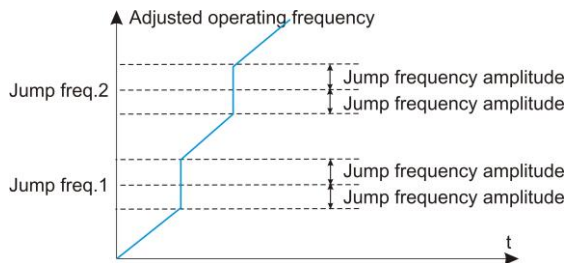

Fig. 6-10 The jump frequency is effective during acceleration and deceleration

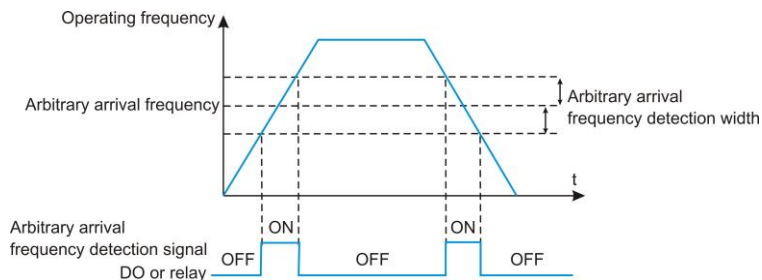

Fig. 6-11 Arbitrary arrival frequency detection

Function Code	Parameter Name	Setting Range	Minimum Unit	Default	Property
P2.23	Frequency switchover point between acceleration time 1 and acceleration time 2	0.00Hz to maximum frequency	0.01Hz	0.00Hz	○
P2.24	Frequency switchover point between deceleration time 1 and deceleration time 2	0.00Hz to maximum frequency	0.01Hz	0.00Hz	○

This function is valid when the motor is selected as motor 1 and the acceleration/deceleration time is not selected by DI terminal switching. It is used to select different acceleration/deceleration time according to the operating frequency range without running through the DI terminal during the running of the inverter.

Figure 6-12 shows the switching of acceleration/deceleration time. In the acceleration

process, if the running frequency is less than P2.23, the acceleration time 2 is selected; if the running frequency is greater than P2.23, the acceleration time 1 is selected.

During deceleration, if the running frequency is greater than P2.24, the deceleration time 1 is selected. If the running frequency is less than P2.24, the deceleration time 2 is selected.

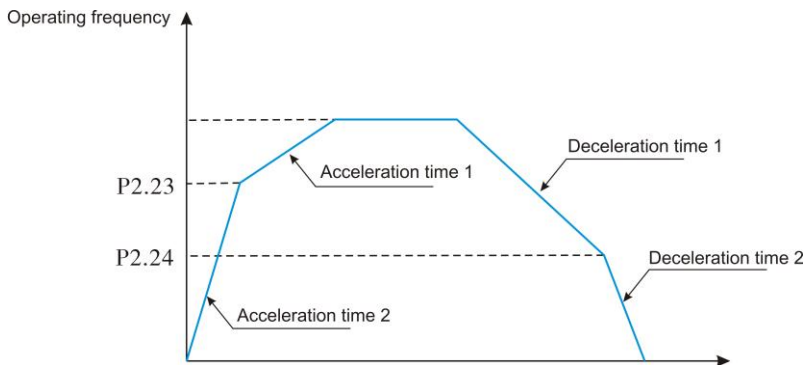

Fig. 6-12 Acceleration/deceleration switching

Function Code	Parameter Name	Setting Range	Minimum Unit	Default	Property
P2.25	Terminal JOG preferred	0~1	1	0	○

**0: Disabled**

**1: Enabled**

When valid, if the terminal jog command appears during operation, the inverter switches to the terminal jog operation state.

Function Code	Parameter Name	Setting Range	Minimum Unit	Default	Property
P2.26	Frequency detection value(FDT2)	0.00Hz to maximum frequency	0.01Hz	50.00Hz	○
P2.27	Frequency detection hysteresis (FDT2)	0.0%~100.0%(FDT2 level)	0.1%	5.0%	○

Refer to the relevant description of FDT1, that is, the description of function code P2.20, P2.21.

Function Code	Parameter Name	Setting Range	Minimum Unit	Default	Property
P2.28	Any frequency reaching detection value 1	0.00Hz to maximum frequency	0.01Hz	50.00Hz	○
P2.29	Any frequency reaching detection amplitude 1	0.0%~100.0% (maximum frequency)	0.1%	0.0%	○
P2.30	Any frequency reaching detection value 2	0.00Hz to maximum frequency	0.01Hz	50.00Hz	○
P2.31	Any frequency reaching detection amplitude 2	0.0%~100.0% (maximum frequency)	0.1%	0.0%	○

When the output frequency of the inverter is within the positive and negative detection range of any arrival frequency detection value, the multi-function DO outputs an ON signal.

Function Code	Parameter Name	Setting Range	Minimum Unit	Default	Property
P2.32	Zero current detection level	0.0 %~300.0 % (100.0% rated motor current)	0.1%	5.0%	○
P2.33	Zero current detection delay time	0.01s~600.00s	0.01s	0.10s	○

When the output current of the inverter is less than or equal to the zero current detection level and the duration exceeds the zero current detection delay time, the inverter multi-function DO outputs ON signal. Figure 6-13 shows the zero current detection.

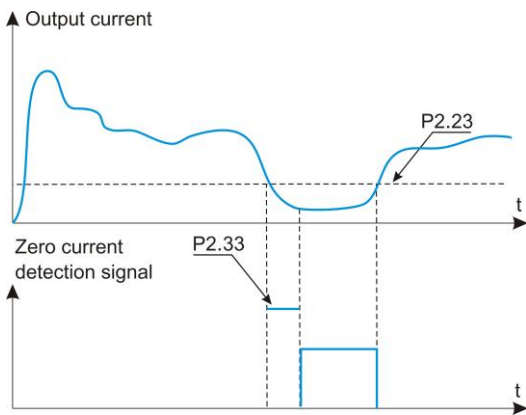

Fig. 6-13 Zero current detection

Function Code	Parameter Name	Setting Range	Minimum Unit	Default	Property
P2.34	Output overcurrent threshold	0.1 %~300.0 % (100.0% rated motor current)	0.1%	200.0%	○
P2.35	Output overcurrent detection delay time	0.01s~600.00s	0.01s	0.00s	○

When P2.34 is 0.0%, it is not detected, and the percentage is set relative to the rated current P8.03 of the motor.

When the output current of the inverter is greater than or exceeds the detection point and the duration exceeds the software over-current detection delay time, the inverter multi-function DO outputs ON signal, and Figure 6-14 shows the output current over-limit function.

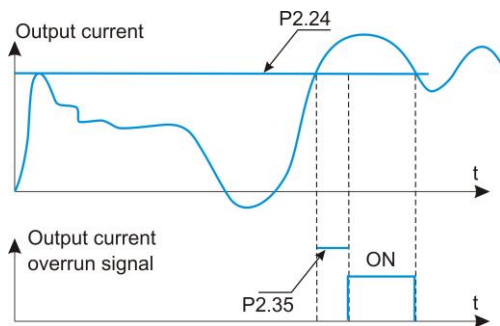

Fig. 6-14 Output current overrun detection

Function Code	Parameter Name	Setting Range	Minimum Unit	Default	Property
P2.36	Any current reaching 1	0.0 %~300.0 % (100.0% rated motor current)	0.1%	100.0 %	○
P2.37	Any current reaching 1 amplitude	0.0 %~300.0 % (100.0% rated motor current)	0.1%	0.0 %	○
P2.38	Any current reaching 2	0.0 %~300.0 % (100.0% rated motor current)	0.1%	100.0 %	○
P2.39	Any current reaching 2 amplitude	0.0 %~300.0 % (100.0% rated motor current)	0.1%	0.0 %	○

The percentage is relative to the rated current of the motor P8.03. When the output current of the inverter is within the positive and negative detection width of any set current, the inverter multi-function DO outputs ON signal.

The NE900 provides two sets of arbitrary arrival current and detection width parameters. Figure 6-15 shows the function.

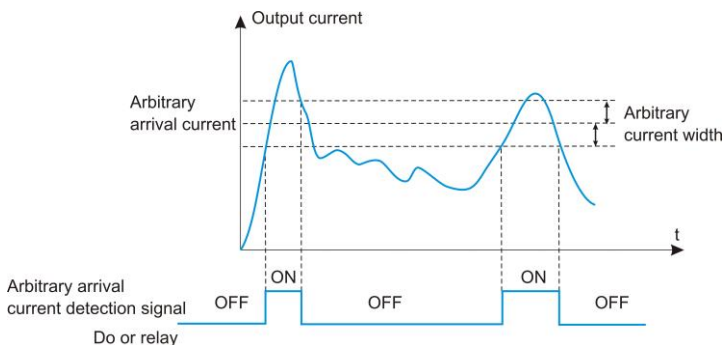

Fig. 6-15 Arbitrary arrival frequency detection

Function Code	Parameter Name	Setting Range	Minimum Unit	Default	Property
P2.40	Timing function	0~1	1	0	○
P2.41	Timing duration selection	0~2	1	0	○
P2.42	Timing duration	0.0Min~6500.0Min	0.1Min	0.0Min	○

This group of parameters is used to complete the timing operation of the inverter.

When the P2.40 timing function selection is valid, the inverter will start timing when it starts. After the set timing running time, the inverter will stop automatically and the multi-function DO will output ON signal.

Each time the inverter starts, it starts from 0, and the remaining running time can be viewed through b0.25. The timing running time is set by P2.41 and P2.42, and the time unit is minute. P2.41 Timing running time selection:

**0: P2.42 setting**

**1: VI**

**2: CI Analog input range corresponds to P2.42;**

**Note:**

- The analog input range corresponds to the P2.42 set time.

Function Code	Parameter Name	Setting Range	Minimum Unit	Default	Property
P2.43	VI input voltage protection lower limit	0.00V~P2.44	0.01V	3.10V	○
P2.44	VI input voltage protection upper limit	P2.44~10.00V	0.01V	6.80V	○

When the value of the analog input VI is greater than P2.43 or the input is less than P2.44, the inverter multi-function DO outputs the "VI analog input overrun" ON signal, which is used to indicate whether the input voltage of the AI is within the set range.

Function Code	Parameter Name	Setting Range	Minimum Unit	Default	Property
P2.45	Module temperature threshold	0~100℃	1	75℃	○

When the temperature of the inverter radiator reaches this temperature, the inverter multi-function DO outputs the "module temperature reached" ON signal.

Function Code	Parameter Name	Setting Range	Minimum Unit	Default	Property
P2.46	Cooling fan control	0~1	1	0	○

### 0: Fan working during running

If the radiator temperature is higher than 40 °C in the stop state, the fan will run. When the radiator is lower than 40 °C in the stop state, the fan will not run.

### 1: Fan working all the time

Function Code	Parameter Name	Setting Range	Minimum Unit	Default	Property
P2.51	Current running time reached	0.0~6500.0Min	0.1Min	0.0Min	○

After the running time of this startup reaches this time, the inverter multi-function digital DO outputs the signal that "this running time reaches" ON.

Function Code	Parameter Name	Setting Range	Minimum Unit	Default	Property
P2.55	Motor output power adjust coefficient	0.1~2	0.1	1	○

Adjust this parameter to calibrate the value of b0.05 output power.



## Group P3: Input Terminals

Function Code	Parameter Name	Setting Range	Minimum Unit	Default	Property
P3.00	Input terminal X1 function selection	0~59	1	1	×
P3.01	X2 function selection	Same as above	1	4	×
P3.02	X3 function selection	Same as above	1	9	×
P3.03	X4 function selection	Same as above	1	12	×
P3.04	X5 function selection	Same as above	1	13	×
P3.05	X6 function selection	Same as above	1	0	×
P3.06	X7 function selection	Same as above	1	0	×
P3.07	X8 function selection	Reserved	1	0	×
P3.08	X9 function selection	Reserved	1	0	×
P3.09	X10 function selection	Reserved	1	0	×

The multi-function input terminals X1 to X10 are provided to the user function, and the user can conveniently select according to the needs, that is, the functions of X1 to X10 are respectively defined by setting the values of P3.00 to P3.09, and the user is referred to Table 6-1. The X1 terminal corresponds to the FWD terminal, and the X2 terminal corresponds to the REV terminal.

*Table 6-1 Multi-function input selection function table*

Value	Function	Value	Function
0	0: No function	1	Forward RUN (FWD)
2	Reverse RUN (REV) or FWD /REV direction	3	Three-line control
4	ExternalForward JOG (FJOG)	5	External Reverse JOG (RJOG)
6	Terminal UP	7	Terminal DOWN
8	Coast to stop (FRS)	9	Fault reset
10	RUN pause	11	Normally open(NO) input of external fault
12	Mult-reference terminal 1	13	Mult-reference terminal 2
14	Mult-reference terminal 3	15	Mult-reference terminal 4
16	Terminal 1 for acceleration /deceleration	17	Terminal 2 for acceleration /deceleration

Value	Function	Value	Function
	time selection		time selection
18	Frequency source switchover	19	UP/DOWN setting clear (terminal, operation panel)
20	Command source switchover 1	21	Acceleration/Deceleration prohibited
22	PID pause	23	PLC status reset
24	Swing pause	25	Counter input
26	Counter reset	27	Length count input
28	Length reset	29	Torque control prohibited
30	PULSE input enabled (only for X5)	31	Reserved
32	Immediate DC braking	33	Normally closed (NC)input of external fault
34	Frequency modification forbidden	35	Reverse PID action direction
36	External STOP terminal 1	37	Command source switchover terminal 2
38	PID integral pause	39	Switchover between main frequency source X and preset frequency
40	Switchover between main frequency source Y and preset frequency	41	Motor selection terminal 1
42	Reserved	43	PID parameter switchover
44	User-defined fault 1	45	User-defined fault 2
46	Speed control/Torque control switchover	47	Emergency stop
48	External STOP terminal 2	49	Deceleration DC braking
50	Clear the current running time	51	Switchover between two-line mode and three-line mode
52	Reverse forbidden	53-59	Reserved

The functions listed in Table 6-1 are described as follows:

### 1~2: Positive and negative control terminals

The inverter is controlled to rotate forward and reverse by external terminals.

### 3: Three-wire operation control

This terminal is used to determine the inverter operation mode is the three-wire control mode. For details, please refer to the description of function code P3.14 ("Terminal Command

---

Method").

#### **4-5: Positive and negative jog**

FJOG is a jog forward run and RJOG is a jog reverse run. For the jog running frequency and jog acceleration/deceleration time, see the descriptions of function codes P2.00, P2.01, and P2.02.

#### **6-7: Frequency increment instruction UP/decrement instruction DOWN**

The frequency is incremented or decremented by the control terminal instead of the operation panel for remote control. When the frequency source is set to digital setting, the set frequency can be adjusted up and down. The rate of change of the terminal UP/DOWN per second is set by function code P3.15.

#### **8: Free parking input**

This function has the same meaning as the free running stop defined in P1.05, but it is realized by the control terminal for remote control.

#### **9: Fault reset (RESET)**

When the inverter has a fault alarm, the fault can be reset through this terminal. Its function is consistent with the STOP button function of the operation panel.

#### **10: Run pause**

The drive decelerates to stop, but all operating parameters are memorized. Such as PLC parameters, swing frequency parameters, PID parameters. After the terminal signal disappears, the inverter returns to the operating state before stopping.

#### **11: External device fault normally open / normally closed input**

Through this terminal, the fault signal of the external device can be input, which is convenient for the inverter to monitor the fault of the external device. After receiving the fault signal of the external device, the inverter displays "E-13", that is, the external device fault alarm. The fault signal can be either normally open or normally closed.

As shown in Figure 6-17, X4 is the normally open input mode. Here, KM is an external device fault relay.

#### **12~15: Multi-speed running terminal**

Four multi-segment command terminals can be combined into 16 states, and each of these 16 states corresponds to 16 command set values. The specific table below shows:

Table 6-2 Command setting values

K4	K3	K2	K1	Command setting	Corresponding parameter
OFF	OFF	OFF	OFF	Multi-segment frequency 0	Pb.00
OFF	OFF	OFF	ON	Multi-segment frequency 1	Pb.01
OFF	OFF	ON	OFF	Multi-segment frequency 2	Pb.02
OFF	OFF	ON	ON	Multi-segment frequency 3	Pb.03
OFF	ON	OFF	OFF	Multi-segment frequency 4	Pb.04
OFF	ON	OFF	ON	Multi-segment frequency 5	Pb.05
OFF	ON	ON	OFF	Multi-segment frequency 6	Pb.06
OFF	ON	ON	ON	Multi-segment frequency 7	Pb.07
ON	OFF	OFF	OFF	Multi-segment frequency 8	Pb.08
ON	OFF	OFF	ON	Multi-segment frequency 9	Pb.09
ON	OFF	ON	OFF	Multi-segment frequency 10	Pb.10
ON	OFF	ON	ON	Multi-segment frequency 11	Pb.11
ON	ON	OFF	OFF	Multi-segment frequency 12	Pb.12
ON	ON	OFF	ON	Multi-segment frequency 13	Pb.13
ON	ON	ON	OFF	Multi-segment frequency 14	Pb.14
ON	ON	ON	ON	Multi-segment frequency 15	Pb.15

When the frequency source is selected as multi-speed, 100.0% of the function code Pb.00~Pb.15 corresponds to the maximum frequency P0.05. In addition to the multi-segment function, the multi-segment command can also be used as a given source of PID, or as a voltage source for VF separation control, etc., to meet the need to switch between different given values. The multi-speed operation wiring diagram is as follows 6-16 (connected to 3 sections).

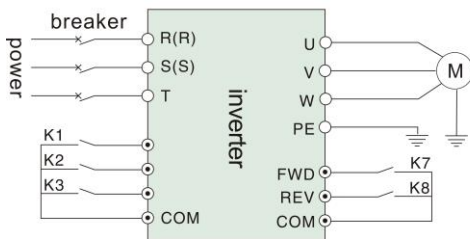

Figure 6-16 Multi-speed operation wiring diagram

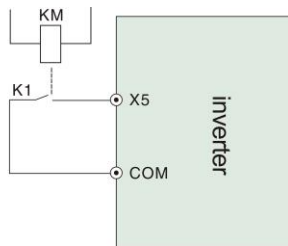

Figure 6-17 External device fault input

### 16~17: Acceleration/deceleration time terminal selection

Table 6-3 Acceleration/deceleration time selection expression

Terminal 2	Terminal 1	Acceleration or deceleration time selection
OFF	OFF	Acceleration time 0 / deceleration time 0
OFF	ON	Acceleration time 1 / deceleration time 1
ON	OFF	Acceleration time 2 / deceleration time 2
ON	ON	Acceleration time 3 / deceleration time 3

The selection of the acceleration/deceleration time 0 to 3 can be achieved by the ON/OFF combination of the acceleration/deceleration time terminals 1 and 2.

### 18: Frequency given switching

Used to switch to a given source of different frequencies.

According to the setting of the frequency source selection function code P0.19, when setting the switching between two kinds of frequency given as the frequency timing, the terminal is used to switch between the two frequency given.

### 19: UP/DOWN setting is cleared

When the frequency is given as the digital frequency, this terminal can clear the frequency value changed by the terminal UP/DOWN or the keyboard UP/DOWN, so that the given frequency returns to the value set by P0.02.

### 20: Run command switch terminal

---

When the running command setting mode is set to terminal control (P0.03=1), this terminal can switch between terminal control and keyboard control.

When the command source is set to communication control (P0.03=2), this terminal can switch between communication control and keyboard control.

#### **21: Acceleration/deceleration prohibition command**

Keep the motor unaffected by any external signals (except for the stop command) and maintain the current speed.

##### **Tip:**

- Invalid during normal deceleration stop.

#### **22: PID suspension**

When the PID is temporarily valid, the inverter maintains the current output frequency and does not perform PID adjustment of the frequency output.

#### **23: PLC status reset**

The PLC is paused during execution. When it is run again, the inverter can be restored to the initial state of the simple PLC through this terminal.

#### **24: swing frequency pause**

The frequency converter outputs at the center frequency. The swing frequency function is suspended.

#### **25: Counter input**

Count the input terminal of the pulse.

#### **26: Counter reset**

The counter status is cleared.

#### **27: length count input**

The function terminal is used for fixed length control, and the length is calculated by pulse input. For details, refer to the function introduction of PE.05~PE.06.

#### **28: Length reset**

When the function terminal is valid, the actual length function code PE.06 is set to zero.

#### **32: Immediate DC braking**

When this terminal is valid, the inverter directly switches to the DC braking state.

#### **33: External fault normally closed input**

---

**34: Frequency setting effective terminal**

If this function is set to valid, the frequency converter will not respond to the frequency change when the frequency changes, until the terminal status is invalid.

**35: PID action direction reverse terminal**

When this terminal is valid, the direction of PID action is opposite to the direction set by P6.03.

**36: External parking terminal 1**

When the keyboard is controlled, this terminal can be used to stop the inverter, which is equivalent to the function of the STOP button on the keyboard.

**37: Control command switching terminal 2**

Used for switching between terminal control and communication control. If the command source is selected as the terminal control, the system switches to communication control when the terminal is valid; vice versa.

**38: PID integration pause terminal**

When the terminal is valid, the PID integral adjustment function is suspended, and the PID proportional adjustment and differential adjustment functions are still valid.

**39: Main frequency reference and preset frequency switching terminal**

When this terminal is valid, the main source of the inverter frequency is replaced by the preset frequency (P0.02).

**40: auxiliary frequency reference and preset frequency switching terminal**

When the terminal is valid, the inverter frequency reference source is replaced by the preset frequency (P2.02).

**43: PID parameter switching terminal**

When the PID parameter switching condition is DI terminal (P6.18=1), when the terminal is invalid, the PID parameter uses P6.05~P6.07. When the terminal is valid, P6.15~P6.17 is used;

**44~45: User-defined fault 1, 2**

When the user-defined faults 1 and 2 are valid, the inverter will alarm E-32 and E-33 respectively, and the inverter will select the action mode selected by PA.46 according to the fault protection action.

---

#### 46: Reserved

#### 47: Emergency stop

When the terminal is valid, the inverter stops at the fastest speed. During the stop process, the current remains at the upper limit which has set. This function is used to meet the requirement that the inverter needs to stop as soon as possible when the system is in an emergency.

#### 48: External STOP terminal 2

In any control mode (keyboard control, terminal control and communication control), this terminal can be used to make the inverter decelerate and stop. The deceleration time is fixed to the Dec. time 4.

#### 49: Deceleration DC braking

When the terminal is valid, the inverter decelerates to the stop DC braking frequency and then switches over to DC braking state.

#### 50: Clear the current running time

When the terminal is valid, the current running time of the inverter is cleared. The function needs to be connected with the timing operation (P2.40) and the operation time arrived (P2.41) used together.

Function Code	Parameter Name	Setting Range	Minimum Unit	Default	Property
P3.10	VI function selection (DI)	0~59	1	1	×
P3.11	CI function selection (DI)	0~59	1	1	×

This group of function codes used to use AI as DI. The AI terminal status is high level when the AI input voltage is greater than 7V and it's low when the AI input voltage is lower than 3V. When the input voltage between 3V and 7V, it's a hysteresis as shown in Fig.6-18.

P3.43 is used to determine whether AI is valid at high level or valid at low level when AI is used as DI.

The function setting is as same as the normal X setting when used AI as DI terminal. Please refer to the description of the relevant X input terminal setting in P3 group.



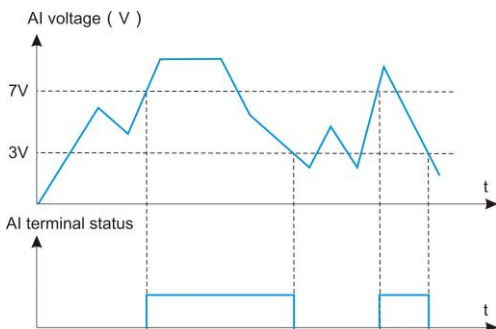

Fig.6-18 Relationship of AI input voltage and corresponding DI status

Function Code	Parameter Name	Setting Range	Minimum Unit	Default	Property
P3.13	Terminal filter time	0.000s~1.000s	1	0.010s	×

Set the software filter time for the X terminal status. If the input terminal is susceptible to interference and causes malfunction, the parameter can be increased so as to enhance anti-interference ability. But increasing the filtering time will cause the X terminal to respond slowly.

Function Code	Parameter Name	Setting Range	Minimum Unit	Default	Property
P3.14	Terminal command mode	0~3	0	0	○

The parameter defines four different ways to control the operation of the inverter via external terminals.

#### 0: Two-line mode 1

K2	K1	RUN Command
0	0	STOP
0	1	Forward RUN
1	0	Reverse RUN
1	1	STOP

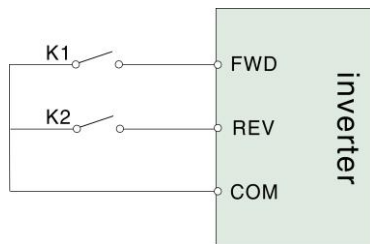

Fig.6-19 Two-line mode 1

### 1: Two-line mode

K2	K1	RUN Command
0	0	STOP
1	0	STOP
0	1	Forward RUN
1	1	Reverse RUN

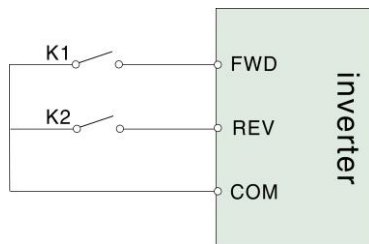

Fig.6-20 Two-line

### 2: Three-line mode 1

Xi is the multi-function input terminals of X1~X6, the corresponding terminal function should be defined as the "3-wire operation control" function of No. 9.

**SB1: Stop button**

**SB2: Forward button**

**SB3: Reverse button**

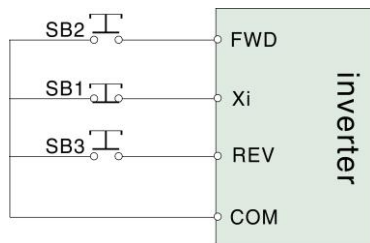

Fig.6-21 Three-line mode 1

### 3: Three-line mode 2

Xi is the multi-function input terminals of X1~X6, the corresponding terminal function should be defined as the "3-wire operation control" function of No. 9.

**SB1: Stop button**

**SB2: Run button**

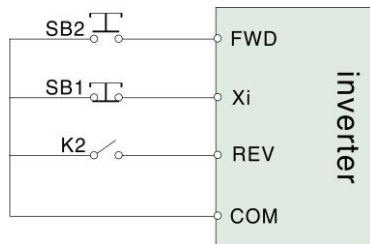

Fig.6-21 Three-line mode 2

**NOTE:** When alarm occurs and stop, if the running command channel selection is terminal valid and the terminal FWD/REV is in the valid state, after reset the fault, the inverter will start immediately.

Function Code	Parameter Name	Setting Range	Minimum Unit	Default	Property
P3.15	Terminal UP/DOWN rate	0.001Hz/s~65.535 Hz/s	0.001Hz/s	1.000Hz/s	○

It is used to adjust the changing rate of frequency  $f$  when the frequency is adjusted by UP/DOWN terminals.

Function Code	Parameter Name	Setting Range	Minimum Unit	Default	Property
P3.16	VI minimum input	0.00V~P3.18	0.01V	0.00V	○
P3.17	Corresponding setting of VI minimum input	-100.0%~+100.0%	0.0%	0.0%	○
P3.18	VI maximum input	P3.16~+10.00V	0.01V	10.00V	×
P3.19	Corresponding setting of VI maximum input	-100.0%~+100.0%	0.0%	100.0%	×
P3.20	VI filter time	0.00s~10.00s	0.01s	0.10s	×
P3.21	CI minimum input	0.00V~P3.23	0.01V	0.00V	○
P3.22	Corresponding setting of CI minimum input	-100.0%~+100.0%	0.0%	0.0%	○
P3.23	CI maximum input	P3.21~+10.00V	0.01V	10.00V	○
P3.24	Corresponding setting of CI maximum input	-100.0%~+100.0%	0.0%	100.0%	○
P3.25	CI filter time	0.00s~10.00s	0.01s	0.10s	○
P3.31	PULSE minimum input	0.00V~P3.33	0.01KHz	0.00KHz	○
P3.32	Corresponding setting of PULSE minimum input	-100.0%~+100.0%	0.0%	0.0%	○
P3.33	PULSE maximum input	P3.31~+100.00KHz	0.01KHz	50.00KHz	○
P3.34	Corresponding setting of PULSE maximum input	-100.0%~+100.0%	0.0%	100.0%	○
P3.35	PULSE filter time	0.00s~10.00s	0.01s	0.10s	○

The above function code is used to set the relationship between the analog input voltage and the set value it represents.

When the voltage of the analog input is larger than the set "maximum input" (P3.18), the analog voltage is calculated according to the "maximum input"; similarly, when the analog input voltage is less than the set "minimum input" ( P3.16), it according to "AI low Select at the minimum input setting (P3.37 setting, calculated with minimum input or 0.0%).

If the analog input is a current input, 1mA current is equivalent to 0.5V.

When the field analog is easily interfered, please increase the filtering time so that the detected analog tends to be stable, but the larger the filtering time, the slower response speed of analog detection.

Please set it properly according to the actual application.

In different applications, the meaning of the nominal value corresponding to 100.0% of the analog setting is different. For more details, please refer to the description of each application section. The following illustrations are for two typical settings:

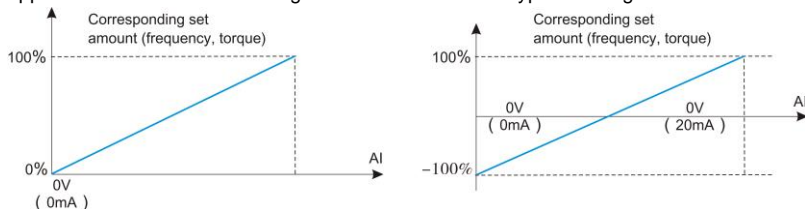

Fig. 6-23 Corresponding relationship between analog input and set values

Function Code	Parameter Name	Setting Range	Minimum Unit	Default	Property
P3.36	VI curve selection	000~333	111	000	○

The unit's digit, ten's digit and hundred's digit of the function code are respectively used to select the corresponding curve of VI and CI. Any of the three curves can be selected for VI and CI.

Curve 1, curve 2 and curve 3 are all 2-point curves, set in group P3. Curve 1 corresponding to P3.16 to P3.20, Curve 2 corresponding to P3.21 to P3.25, Curve 3 corresponding to P3.26 to P3.30.

Function Code	Parameter Name	Setting Range	Minimum Unit	Default	Property
---------------	----------------	---------------	--------------	---------	----------

Function Code	Parameter Name	Setting Range	Minimum Unit	Default	Property
P3.37	Setting for AI less than minimum input	000~333	111	000	○

This function code is used to set how to select the analog corresponding value, when the voltage of the analog input is less than the set "minimum input".

The unit's digit and ten's digit of the function code correspond to the VI and CI inputs.

If the selection is 0, when the AI input is lower than the "minimum input", the corresponding setting of the analog is the curve "minimum input corresponding setting" determined by the function code (P3.16, P3.22, P3. 26).

If the selection is 1, the analog input is set to 0.0% when the AI input is lower than the minimum input.

Function Code	Parameter Name	Setting Range	Minimum Unit	Default	Property
P3.38	X1 delay time	0.0s~3600.0s	0.1s	0.0s	×
P3.39	X2 delay time	0.0s~3600.0s	0.1s	0.0s	×
P3.40	X3 delay time	0.0s~3600.0s	0.1s	0.0s	×

It is used to set the delay time for the inverter operation when the state of the X terminal cahnged. At present, only X1, X2, and X3 have the function of setting the delay time.

Function Code	Parameter Name	Setting Range	Minimum Unit	Default	Property
P3.41	X valid mode selection 1	00000~11111	000	00000	×
P3.42	X valid mode selection 2	00000~11111	000	00000	×
P3.43	AI as valid status selection	000~111	000	000	×
P3.44	Input phase loss judgment time	0.1~6553.5	0.1	5.0	×

#### 0: High level valid

#### 1: Low level valid

The group of function codes is used to set the valid status mode of the digital input terminal.

When each bit is selected to be high level valid, the corresponding X terminal is valid when it is connected to COM, and the disconnection is invalid. When the selection is low level valid,

the corresponding X terminal is invalid when it is connected to COM, and the disconnection is valid.

P3.41 Control terminal bit description: Unit's digit: X1, ten's digits: X2, hundred's digits: X3, thousand's digits: X 4, Ten thousand's digits: X5.

P3.42 Control terminal bit description: Unit's digit: X6, ten's digits: X7, hundred's digits: X8, thousand's digits: X9, Ten thousand's digits: X10

P3.43 control terminal bit Description: Unit's digit: VI, ten's digits: CI.

## Group P4: Output Terminals

Function Code	Parameter Name	Setting Range	Minimum Unit	Default	Property
P4.00	FM terminal output mode	0~1	1	0	○

### 0: Pulse output (FMP)

#### 1: Switch signal output (FMR)

The FM terminal is a programmable multiplexer that can be used as a high-speed pulse output terminal or as an open-collector output. The maximum frequency of the output pulse is 100KHz. Please refer to the description of P4.06 for the pulse output related functions.

Function Code	Parameter Name	Setting Range	Minimum Unit	Default	Property
P4.01	FM open-switch output function selection	0~41	1	0	○
P4.02	Relay function T/A-T/B-T/C	0~41	1	2	○
P4.03	Extension card relay function (R/A-R/B-R/C)	0~41	1	0	○
P4.04	DO1 function selection (Reserved)	0~41	1	1	○
P4.05	DO2 function selection (Reserved)	0~41	1	4	○

The above five function codes are used to select the functions of the five digital outputs, where T/A-T/B-T/C and P/A-P/B-P/C are respectively two relays.

The function of the multi-function output terminal is as follows:

Table6-4 Output terminals function

Value	Function	Value	Function
00	No output	01	Inverter running
02	Fault output (stop)	03	Frequency-level detection FDT1 output
04	Frequency reached	05	Zero-speed running(No output at stop)
06	Motor overload pre-warning	07	inverter overload pre-warning
08	Set count value reached	09	Designated count value reached
10	Length reached	11	PLC cycle complete
12	Accumulative running time reached	13	Frequency limited
14	Torque limited	15	Ready for RUN
16	VI >CI	17	Frequency upper limit reached
18	Frequency lower limit reached	19	Under voltage state output
20	Communication setting	21	Positioning complete
22	Positioning approach	23	Zero-speed running 2 (having output at stop)
24	Accumulative power-on time reached	25	Frequency level detection FDT2 output
26	Frequency 1 reached	27	Frequency 2 reached
28	Current 1 reached	29	Current 2 reached
30	Timing reached	31	VI input limit exceeded
32	Load becoming 0	33	Reverse running
34	Zero current state	35	Module temperature reached
36	Software current limit exceeded	37	Frequency lower limit reached (having output at stop)
38	Alarm output(all faults)	39	Motor overheat warning
40	Current running time reached	41	Fault output (there is no output if it is the coast to stop fault and under voltage occurs)

The functions listed in Table 6-4 are as follows:

**0: No output**

The output terminal has no function.

---

### **1: Inverter running**

When the inverter is in running state and has output frequency (can be zero), it outputs ON signal.

### **2: Fault output (stop)**

When fault occurs and the inverter free stop, it outputs ON signal.

### **3: Frequency-level detection FDT1 output**

Please refer to the description of function codes P2.19 and P2.20.

### **4: Frequency reached**

Please refer to the description of function code P2.21.

### **5: Zero- speed running (No output at stop)**

When the inverter runs and the output frequency is 0, it outputs ON signal.

This signal is OFF when the inverter is in the stop state.

### **6: Motor overload pre-warning**

According to the threshold value of the overload pre-alarm and before the motor overload protection action, it outputs ON signal when the pre-alarm threshold is exceeded.

Please refer to function code PA.00~PA.02 for motor overload parameter setting.

### **7: Inverter overload pre-alarming**

It outputs ON signal 10s before the inverter overload protection occurs.

### **8: Set count value reached**

When the count value reaches the value set in PE.08, it outputs ON signal.

### **9: Designated count value reached.**

When the count value reaches the value set by PE.09, it outputs ON signal.

Please refers to the PE group function description for the counting functions.

### **10: Length reached**

When the detected actual length exceeds the length set by PE.05, it outputs ON signal.

### **11: PLC cycle complete**

When the simple PLC operation completes a cycle, it outputs a pulse signal with a width of 250ms.

### **12: Accumulative running time reached**



---

When the inverter running time more than the time set by P2.51, it outputs ON signal.

**13: Frequency limited**

When the set frequency exceeds the upper limit frequency or the lower limit frequency, and the output frequency also reaches the upper limit frequency or the lower limit frequency, it outputs ON signal.

**14: Torque limited**

In speed control mode, when the output torque reaches the torque limit value, the inverter is in the stall protection state and outputs ON signal.

**15: Ready for RUN**

When the power supply of the main circuit and the control circuit of the inverter have been stabilized, and the inverter does not detect any fault information, it outputs ON signal during operation.

**16: VI>CI**

When the analog input value VI is larger than the input value of CI, it outputs ON signal.

**17: Frequency upper limit reached**

When the running frequency reaches the set upper limit frequency, it outputs ON signal.

**18: Frequency lower limit reached**

When the running frequency reaches the lower limit frequency, it outputs ON signal, also valid during stop state.

**19: Under voltage state output**

When the inverter is in under voltage state, it outputs ON signal.

**20: Communication setting**

The output of the DO is controlled by communication. For the control bits, please refer to Chapter 9 "NE900 Serial Port RS485 Communication Protocol".

**21: Positioning complete**

**22: Positioning approach**

**23: Zero-speed running 2 (having output at stop)**

When the inverter output frequency is 0, it outputs ON signal and also valid during stop state.

**24: Accumulative power-on time reached.**

---

When the accumulated running time of the inverter exceeds the time set by P2.16, it outputs ON signal.

**25: Frequency level detection FDT2 output**

Please refer to the description of function codes P2.26 and P2.27.

**26: Frequency 1 reached**

Please refer to the description of function codes P2.28 and P2.29.

**27: Frequency 2 reached**

Please refer to the description of function code P2.30 and P2.31.

**28: Current 1 reached**

Please refer to the description of function codes P2.36 and P2.37.

**29: Current 2 reached**

Please refer to the description of function codes P2.38 and P2.39.

**30: Timing reached**

When the timing function selection (P2.40) is valid, the inverter will output the ON signal after the current running time reaches the set timing time (P2.42).

**31: VI input limit exceeded**

When the value of the analog VI is greater than P2.44 (VI input protection upper limit) or less than P2.43 (VI input protection protection low limit), it will outputs ON signal.

**32: Load becoming 0**

When the inverter is in the off load state, it will output ON signal.

**33: Reverse running**

When the inverter is in reverse running state, it outputs ON signal.

**34: Zero current state**

Please refer to the description of function code P2.32 and P2.33.

**35: Module temperature reached**

When the inverter IGBT heatsink temperature (P7.06) reaches the set IGBT temperature reach value (P2.45), it outputs ON signal.

**36: Software current limit exceeded**

---

Please refer to the description of P2.34-P2.35 for details.

**37: Frequency lower limit reached (having output at stop)**

When the running frequency reaches the lower than limit frequency, it outputs ON signal during operation, the signal still ON when the machine is stopped.

**38: Alarm output (all faults)**

When any fault occurs and the inverter free stop, it outputs ON signal.

**39: Motor overheat warning**

When the motor temperature (b0.34) reaches PA.54 (motor overheat pre-alarm threshold), it outputs ON signal.

**40: Current running time reached**

It outputs ON signal when the operation time exceeds the set time of P2.51.

**41: Fault output** (there is no output if it is the coast to stop fault and under voltage occurs)

When the inverter fails and the fault processing mode is not continued, it outputs ON signal.

**Note:** It without output when the fault is undervoltage.

Function Code	Parameter Name	Setting Range	Minimum Unit	Default	Property
P4.06	FMP output function selection	0~16	1	0	○
P4.07	AO1 output selection	0~16	1	0	○
P4.08	AO2 output selection	0~16	1	1	○

The high-speed pulse output pulse frequency range is 0.01 KHz to P5.09 (pulse output maximum frequency), and P5.09 can be set between 0.01 KHz and 100.00 KHz. The output range of analog output AO1 and AO2 is 0V~10V or 0mA~20mA.

The range of pulse output or analog output and the calibration relationship of the corresponding function are shown in the following table: The function of the multi-function output terminal is as follows:

*Table 6-5 Pulse or analog output corresponding function table*

Set Value	Function	Function corresponding to 0.0%~100.0% output of pulse or analog
1	Operation frequency	0~Maximum output frequency

Set Value	Function	Function corresponding to 0.0%~100.0% output of pulse or analog
2	Set frequency	0~Maximum output frequency
3	Output current	0~2*motor rated current
4	Output torque	0~2*motor rated torque
5	Output voltage	0~1.2*motor rated voltage
6	PULSE input	0.01KHz~100.00 KHz
7	VI	0~10V
8	CI	0~10V(or 4~20mA)
9	---	---
10	Length	0~Maximum set length
11	Count value	0~Maximum count value
12	Communication set	0.0%~100.0%
13	Motor speed	0~Speed corresponding to maximum output frequency
14	Output current	0.0A~1000.0A
15	Output voltage	0.0V~1000.0V
16	Output torque	-2*motor rated torque~2*motor rated torque

Function Code	Parameter Name	Setting Range	Minimum Unit	Default	Property
P4.09	FMP output maximum frequency	0.01KHz~100.00KHz	0.01KHz	50.00KHz	○

When select FM terminal as pulse output,the function code used to set the maximum output frequency.

Function Code	Parameter Name	Setting Range	Minimum Unit	Default	Property
P4.10	AO1 offset coefficient	-100.0%~+100.0%	0.001	0.0%	○
P4.11	AO1 gain	-10.00~+10.00	0.01	1.00	○
P4.12	AO2 offset coefficient	-100.0%~+100.0%	0.001	0.0%	○

Function Code	Parameter Name	Setting Range	Minimum Unit	Default	Property
P4.13	AO2 gain	-10.00~+10.00	0.01	1.00	○

The above function codes are generally used to correct the zero drift and the output amplitude deviation of the analog output. It can also be used to customize the required AO output curve. If the zero offset is represented by "b", the gain is represented by k, the actual output is represented by Y and the standard output is represented by X, the actual output is:  $Y = kX + b$ .

The zero offset coefficient 100.0% of AO1 and AO2 corresponds to 10V (or 20mA). The standard output means the amount corresponding to the analog output of 0V~10V (or 0mA~20mA) which without zero offset and gain correction. For example, if the analog output is the operation frequency, it outputs 8V when the frequency is 0, and 3V when the frequency is the maximum frequency, then the gain should be set to "-0.50" and the zero offset should be set to "80%".

Function Code	Parameter Name	Setting Range	Minimum Unit	Default	Property
P4.14	FMR output delay time	0.0s~3600.0s	0.1s	0.0s	○
P4.15	Relay 1 output delay time	0.0s~3600.0s	0.1s	0.0s	○
P4.16	Relay 2 output delay time	0.0s~3600.0s	0.1s	0.0s	○
P4.17	DO1 output delay time	0.0s~3600.0s	0.1s	0.0s	○
P4.18	DO2 output delay time	0.0s~3600.0s	0.1s	0.0s	○

Set the delay time of output terminals FMR, Relay 1, Relay 2, DO1, and DO2 from the state change to the actual output change.

Function Code	Parameter Name	Setting Range	Minimum Unit	Default	Property
P4.19	Switch output terminal valid status	00000~11111	11111	00000	○

The function used to define the output logic of the output terminal FMR, Relay 1, Relay 2, DO1 and DO2.

**The description of each digit as below:**

- ◆ Unit's digit: Output terminal FMR;
- ◆ Ten's digit: Relay1 output;

- ◆ Hundred's digit: Relay 2 output;
- ◆ Thousand's digit: YDO1 output;
- ◆ Ten thousand's digit: DO2 output

#### 0: Positive logic

It's valid when the digital output terminal connect with COM.It's invalid when disconnection.

#### 1: Negative logic

It's invalid when the digital output terminal and the corresponding COM terminal connected together.Valid when it's disconnection.

### Group P5: V/F curve parameters

Function Code	Parameter Name	Setting Range	Minimum Unit	Default	Property
P5.00	V/F curve setting	0~11	1	00	x

The function codes define a flexible V/F setting method to meet different load characteristics requirements. Five curve modes can be selected according to the definition of P5.00.

#### 0: Linear V/F

It applicable to ordinary constant torque load. When the output frequency of the inverter is 0, the output voltage is 0 and when the output frequency is the rated frequency of the motor, the output voltage is the rated voltage of the motor.

#### 1: Multi-point V/F

It suitable for special loads such as dehydrators and centrifuges. By setting the P5.01~P5.06 parameters, an arbitrary VF relationship curve can be obtained.

#### 2: Square V/F

It suitable for centrifugal loads such as fans and pumps.

#### 10: V/F complete separation

Generally used in induction heating, torque motor control and other occasions. The output frequency of the inverter is independent of the output voltage, the output frequency is determined by the frequency source and the output voltage is determined by P5.14 (the voltage source digital setting when select separated V/F).

## 11: V/F half separation

V is proportional to F, but the proportional relationship can be set by separated V/F voltage source P5.13, and the relationship between V and F is also relating to the rated voltage and rated frequency of the motor in P8 group. Assuming that the voltage source input is X (X is 0~100%), the relationship between the inverter output voltage V and the frequency F is:  $V/F=2 * X * (\text{motor rated voltage}) / (\text{motor rated frequency})$ .

Function Code	Parameter Name	Setting Range	Minimum Unit	Default	Property
P5.01	Torque boost	0.0%~30.0%	0.1%	Model depend	○

It used to improve the low frequency torque characteristics of the inverter,boosting and compensating the output voltage.The decreasing torque curve and the constant torque curve boost are shown in a and b of Fig.6-24.

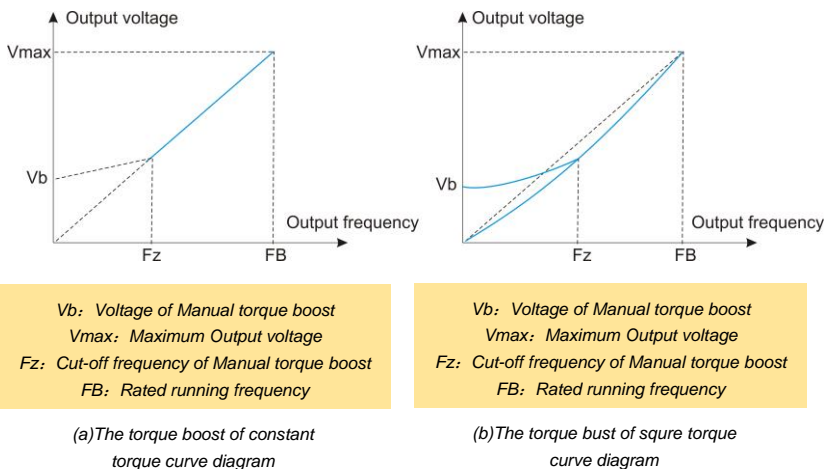

Fig.6-24 Manual torque boost

Function Code	Parameter Name	Setting Range	Minimum Unit	Default	Property
P5.02	Cut-off frequency of torque boost	0.00Hz to maximum output frequency	0.01Hz	50.00Hz	×

The function defines the cut-off frequency of the manual torque boost.

Please refer to Fz in Fig.6-24, which applies to all the V/F curve that defined by P5.00.

Function Code	Parameter Name	Setting Range	Minimum Unit	Default	Property
P5.03	Multi-point V/F frequency 1	0.00Hz~P5.05	0.01Hz	0.00Hz	×
P5.04	Multi-point V/F voltage 1	0.0%~100.0%	0.1%	0.0%	×
P5.05	Multi-point V/F frequency 2	P5.03~P5.07	0.01Hz	0.00Hz	×
P5.06	Multi-point V/F voltage 2	0.0%~100.0%	0.1%	0.0%	×
P5.07	Multi-point V/F frequency 3	P5.05 to rated motor frequency	0.01Hz	0.00Hz	×
P5.08	Multi-point V/F voltage 3	0.0%~100.0%	0.1%	0.0%	×

The user can customize the V/F curve through P5.03~P5.08, as shown in Fig. 6-25 below.

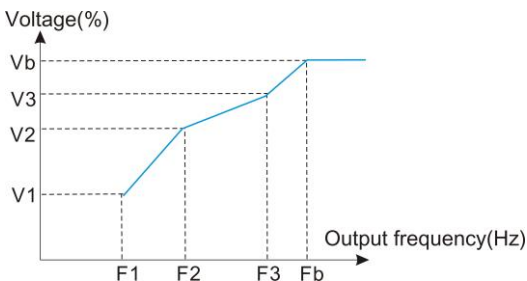

V1~V3: 1~3 Voltage percentages of multi-point V/F  
F1~F3: 1~3 Frequency percentages of multi-point V/F  
Fb: Motor rated frequency

Fig.6-25 Multi-point V/F frequency voltage diagram

Function Code	Parameter Name	Setting Range	Minimum Unit	Default	Property
P5.09	V/F slip compensation gain	0.0%~200.0%	0.1%	0.0%	○

When the motor works at V/F control mode and drives a electric load, the motor speed will decrease as load increases. If it drives a generation load, the motor speed will increase as the load increases. By setting the slip compensation gain value properly, the motor speed change due to load changes can be compensated to maintain a constant motor speed.

To use the slip compensation function normally, the motor rated speed P8.05 must be



correctly set according to the motor nameplate. P8.05 is the speed at which the motor drives the rated electric load. The rated slip is the difference between the rated speed and the speed at non-load operation. Slip compensation automatically adjusts the output frequency of the inverter according to the rated slip and the magnitude of the motor load by detecting the motor load in real time, thereby reducing the influence of load changes on the motor speed.

Gain adjustment method: Please adjust it around 100%. When the motor drives electric load, if the motor speed is low, increase the gain properly; if the motor speed is high, reduce the gain properly. When the motor drives generation load, if the motor speed is low, the gain is properly reduced. If the motor speed is high, increase the gain properly.

Function Code	Parameter Name	Setting Range	Minimum Unit	Default	Property
P5.10	V/F over-excitation gain	0~200	1	64	○

During the deceleration of the inverter, the over-excitation control can suppress the rise of the bus voltage and avoid overvoltage faults. The larger the over-excitation gain, the better the suppression effect. In the applications where easy to give overvoltage alarm during inverter deceleration process, it is necessary to increase the overexcitation gain. However, if the over-excitation gain is too large, it will easily lead to an increase in the output current, which needs to be weighed in different application. It is recommended to set the over-excitation gain to 0 for the applications where the inertia is small and there is no voltage rise during motor deceleration. For those applications with braking resistors, it's also recommended to set the over-excitation gain to 0.

Function Code	Parameter Name	Setting Range	Minimum Unit	Default	Property
P5.11	V/F oscillation suppression gain	0~100	1	Model depend	○

In the V/F control mode, the motor is easy to occur oscillation of the speed and current due to load disturbance during operation. In severe cases, the system may not operate normally or even overcurrent protection, especially in the case that there is no load or light load. Setting reasonable parameters of P5.11 can effectively suppress the oscillation of motor speed and current. Generally, it does not need to be changed. If really need to change it, please adjust it gradually around the factory value. Do not set it too large, otherwise it will affect the V/F control performance.

Function Code	Parameter Name	Setting Range	Minimum Unit	Default	Property
P5.13	Voltage source for V/F separation	0~8	0	00	○

The function is valid when P5.00 is set to 10 or 11: V/F separation.

#### 0: Digital setting

The voltage is set by PA.13 directly.

1: VI

2: CI

3:-----

#### 4: PULSE setting

The voltage reference is given by the high-speed terminal pulse terminal X5. Pulse reference signal specifications: voltage range 9V ~ 30V, frequency range 0KHz ~ 100KHz.

#### 5: Multi-reference

When the voltage source is a multi-segment command, the PF group parameters should be set to determine the correspondence between the given signal and the given voltage. The PF group parameter is 100.0% given by the multi-segment command, which is the percentage relative to the rated voltage of the motor.

#### 6: Simple PLC

When the voltage source is from simple PLC, you need to set the PF group parameters to determine the given output voltage.

#### 7: PID

It provides an output voltage according to the PID closed loop. For more details, please refer to the PID introduction in PE group.

#### 8: Communication setting

The voltage is given by the host computer through communication. The VF separation voltage source selection is similar to the frequency reference selection method, like P0.01 Main Frequency Reference Selection. The 100.0% of the various types of selection corresponds to the motor rated voltage (the corresponding setting is the absolute value).

Function Code	Parameter Name	Setting Range	Minimum Unit	Default	Property
---------------	----------------	---------------	--------------	---------	----------

Function Code	Parameter Name	Setting Range	Minimum Unit	Default	Property
P5.14	Voltage digital setting for V/F separation	0V to rated motor voltage	1	0V	○

The output voltage set by P5.14 when set P5.13 as 0.

Function Code	Parameter Name	Setting Range	Minimum Unit	Default	Property
P5.15	Voltage acceleration time of V/F separation	0.0s~1000.0s	0.1s	0.0s	○

The voltage acceleration time of V/F separation is the time required for the output voltage to change from 0V to the motor rated voltage.

## Group P6: PID Function parameters

PID control is a common method of process control. By proportional, integral and differential calculation of the difference between the controlled feedback signal and the the target signal, it adjusts the output to form a closed-loop system and controlled signal stable and near the target value. It is suitable for process control situations such as flow control, pressure control and temperature control. The control principle of process PID as shown in Fig.6-26.

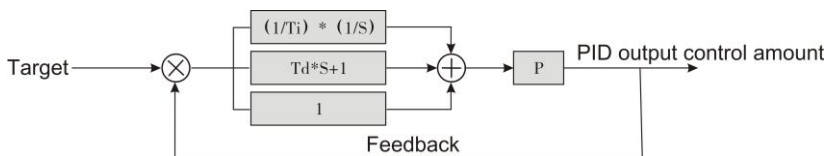

Fig.6-26 The principle diagram of process PID

Function Code	Parameter Name	Setting Range	Minimum Unit	Default	Property
P6.00	PID setting source	0~6	1	0	×
P6.01	PID digital setting	0.0%~100.0%	1%	50.0%	○

### 0: P6.01 setting

1: VI

---

## 2: CI

### 4: Pulse setting

### 5: Communication setting

### 6: Multi-reference setting

P6.00 used to select the channel of target the process PID setting.

The PID target setting is a relative value and the range is 0.0% to 100.0%. The PID feedback is also a relative value. The purpose of PID control is to make the PID setting and PID feedback equal.

Function Code	Parameter Name	Setting Range	Minimum Unit	Default	Property
P6.02	PID feedback source	0~8	1	0	○

## 0: Analog VI

### 1: Analog CI

### 2: Reserved

### 3: VI-CI

### 4: PULSE setting (X5/HDI)

### 5: Communication setting

### 6: VI+CI

### 7: MAX(|VI|, |CI|)

### 8: MIN (|VI|, |CI|)

The parameter is used to select the feedback channel of the process PID. The feedback is also a relative value and the setting range is 0.0%~100.0%.

Function Code	Parameter Name	Setting Range	Minimum Unit	Default	Property
P6.03	PID action direction	0~1	1	0	○

## 0: Forward action

When the PID feedback signal is less than the target set value, the inverter output frequency will rise, like the winding tension control occasions.

## 1: Reverse action

When the feedback signal of the PID is less than the target set value, the inverter output frequency decreases, like the unwinding tension control occasions. Please note that the function is affected by the reverse direction of the multi-function terminal PID (function 35) when you use it.

Function Code	Parameter Name	Setting Range	Minimum Unit	Default	Property
P6.04	PID setting feedback range	0~65535	1	1000	○

The range of the PID target and feedback has no unit and it just for the display of b0.15 PID target setting and b0.16 PID feedback.

The relative value 100.0% of the PID target and feedback is corresponding to the target and feedback range P6.04. For example, if P6.04 is set to 2000, then

When the PID target is 100.0%, the PID target setting display b0.15 is 2000.

Function Code	Parameter Name	Setting Range	Minimum Unit	Default	Property
P6.05	Proportional gain KP1	0.0~100.0	0.1	20.0	○
P6.06	Integral time T11	0.01s~10.00s	0.01s	2.00s	○
P6.07	Differential time TD1	0.000s~10.000s	0.001s	0.000s	○

### P6.05: Proportional gain KP1

It determines the adjustment strength of the entire PID regulator, the larger the Kp1, the greater the adjustment intensity. If set the parameter as 100.0, it indicates that when the deviation between the PID feedback and the target set is 100.0%, the adjustment range of the PID regulator is the maximum frequency.

### P6.06: Integral time T11

It determines the strength of the PID regulator integral adjustment. The shorter the integration time, the greater the adjustment intensity. The integration time is the period to reach the maximum frequency after continuously adjusting of the integral regulator when the deviation between the PID feedback and the target set is 100.0%.

### P6.07: Differential time TD1

It determines the strength of the PID regulator to adjust the deviation rate. The longer the

differentiation time, the greater the adjustment intensity. It means that when the feedback changes by 100.0% during this time, the adjustment amount of the differential regulator is the maximum frequency.

Function Code	Parameter Name	Setting Range	Minimum Unit	Default	Property
P6.08	Cut-off frequency of PID reverse rotation	0.00 to maximum frequency	0.01 Hz	2.00Hz	○

In some situations, only when the PID output frequency is a negative value (Inverter reverse rotation), the PID control of the target set and the feedback can be equal. But too high reverse rotation frequency is not allowed for some occasions, so the parameter is used to determine the upper limit frequency of the reverse rotation.

Function Code	Parameter Name	Setting Range	Minimum Unit	Default	Property
P6.09	PID deviation limit	0.0%~100.0%	0.1%	0.0%	○

If the deviation between PID feedback and PID setting is smaller than the value of P6.09, PID control stops. The small deviation between PID feedback and PID target setting will make the output frequency stabilize, effective for some closed-loop control applications.

Function Code	Parameter Name	Setting Range	Minimum Unit	Default	Property
P6.10	PID differential limit	0.00%~100.00 %	0.01%	0.10%	○

P6.10 is used to set the PID differential output range.

In PID control, the differential operation is relatively sensitive and may cause system oscillation easily. Thus, the PID differential regulation is restricted to a small range.

Function Code	Parameter Name	Setting Range	Minimum Unit	Default	Property
P6.11	PID setting change time	0.00~650.00s	0.01s	0.00s	○

The PID setting change time is the time required for PID setting changing from 0.0% to 100.0%. The PID setting changes linearly according to the change time, reducing the impact caused by sudden setting change on the system.

Function Code	Parameter Name	Setting Range	Minimum Unit	Default	Property
P6.14	Reserved	-	-	-	○
P6.15	Proportional gain KP2	0.0~100.0	0.1	20.0	○
P6.16	Integral time TI2	0.01s~10.00s	0.01s	2.00s	○
P6.17	Differential time TD2	0.000s~10.000s	0.001s	0.000s	○
P6.18	PID parameter switchover condition	0~3	1	0	○
P6.19	PID parameter switchover deviation 1	0.0%~P6.20	0.1%	20.0%	○
P6.20	PID parameter switchover deviation 2	P6.19~100.0%	0.1%	80.0%	○

These parameters are used for switchover between two groups of PID parameters.

P6.18 sets the PID switching condition:

- 0: No switchover;**
- 1: Switchover via Xi;**
- 2: Automatic switchover based on deviation;**
- 3: Automatic switchover based on running frequency.**

The regulator parameters P6.15~ P6.16 are set in the same way as P6.05~ P6.07.

If select switchover via multi-function DI terminal, the terminal function selection should be set to 37 (PID parameter switchover terminal).

When the terminal is invalid, parameter group 1 (P6.05~ P6.07) is selected. When the terminal is valid, the parameter group 2 (P6.15~ P6.16) is selected.

If automatic switchover is selected, the absolute value of the deviation between the PID setting and feedback is less than the PID parameter switching deviation 1 (P6.19), group 1 is selected. When the absolute value of the deviation between the PID setting and the feedback is greater than the PID switching deviation 2 (P6.20), it selects group 2.

When the deviation between the PID setting and feedback is between the switching deviation 1 and the switching deviation 2, the PID parameters are the linear interpolation value of the two groups of PID parameters, as shown in Fig.6-27.

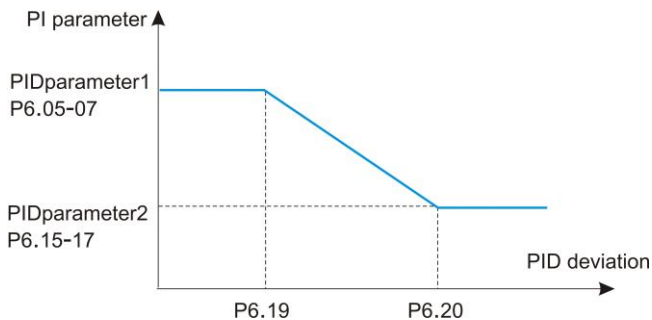

Fig.6-27 PID parameters switchover

Function Code	Parameter Name	Setting Range	Minimum Unit	Default	Property
P6.21	PID initial value	0. 0%~100.0 %	1	0. 0%	○
P6.22	PID initial value holding time	0.00~650.00s	0.01s	0.00s	○

When the inverter starts up, the PID starts closed-loop algorithm only after the PID output is fixed to the PID initial value (P6.21) and lasts the time set in P6.22, as shown in Fig. 6-28.

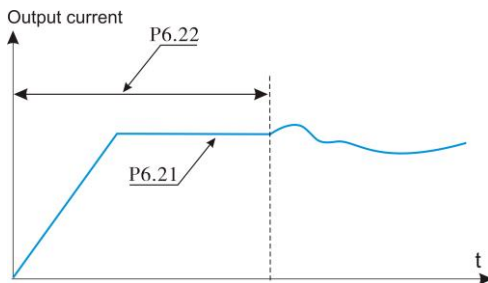

Fig.6-28 PID initial value function

Function Code	Parameter Name	Setting Range	Minimum Unit	Default	Property
P6.23	Maximum deviation between two PID outputs in forward direction	0.00%~100.00%	0.01%	1.00%	○



Function Code	Parameter Name	Setting Range	Minimum Unit	Default	Property
P6.24	Maximum deviation between two PID outputs in reverse direction	0.00%~100.00%	0.01%	1.00%	○

The function is used to limit the deviation between two PID outputs (2 ms per PID output) to suppress the rapid change of PID output and stabilize the running of the inverter.

P6.23 and P6.24 respectively correspond to the maximum absolute value of the output deviation in forward direction and in reverse direction.

Function Code	Parameter Name	Setting Range	Minimum Unit	Default	Property
P6.25	PID integral property	00~11	00	00	P6.25

**Unit's digit: Integral separated**

**0: Invalid**

**1: Valid**

If integral separated function is valid, the PID integral operation stops when the DI allocated with function 38 "PID integral pause" is valid. In this case, only proportional and differential operations take effect.

If it's invalid, integral separated function remains invalid no matter whether the DI allocated with function 38 "PID integral pause" is ON or not.

**Ten's digit: Whether to stop integral operation when the output reaches the limit**

**0: Continue integral operation**

**1: Stop integral operation**

The user can select it whether stop integral operation or not when the output of PID calculation reached the maximum or minimum value.

If "Stop integral operation" is selected, the PID integral operation stops, which may help to reduce the PID overshoot.

Function Code	Parameter Name	Setting Range	Minimum Unit	Default	Property
P6.26	Detection value of PID feedback loss	0.1%~100.0%	0.1%	0.0%	○
P6.27	Detection time of PID feedback loss	0.0s~20.0s	0.1s	1.0s	○

These parameters are used to judge whether PID feedback is lost.

It not judge feedback loss when set P6.26 as 0.0%, If the PID feedback is smaller than the value of P6.26 and the lasting time exceeds the value of P6.27, the inverter reports E-31 fault and acts according to the selected fault protection action.

Function Code	Parameter Name	Setting Range	Minimum Unit	Default	Property
P6.28	PID operation at stop	0~1	1	0	○

#### 0: No PID operation at stop

#### 1: PID operation at stop

It is used to select whether to continue PID operation in the state of stop. Generally, the PID operation stops when the inverter stops

Function Code	Parameter Name	Setting Range	Minimum Unit	Default	Property
P6.30	Given pressure	0.001~P6.31 MPa	0.001Mpa	0.500Mpa	○

The panel of the inverter displays SLEEP in the sleep state. When P0.01=10, directly set the pressure digital setting through P6.30, and use the keyboard ▲ and ▼ keys to fine-tune at the same time, which is convenient for customers to fine-tune the set value through the keyboard.

Function Code	Parameter Name	Setting Range	Minimum Unit	Default	Property
P6.31	Maximum value set by up and down keys	0.001~P6.04 MPa	0.001Mpa	1.000Mpa	○
P6.32	Minimum value set by up and down keys	0.001~P6.31 MPa	0.001Mpa	0	○

This parameter is used to limit the upper and lower limits of pressure setting. When the set pressure is greater than the value of P6.31, the maximum set pressure is the value of P6.31. When the set pressure is less than the value of P6.30, the set pressure The minimum value is P6.32.

Function Code	Parameter Name	Setting Range	Minimum Unit	Default	Property
P6.33	Alarm upper limit pressure output	0.001~P6.04 MPa	0.001Mpa	1.000Mpa	○

When the pipe network pressure is greater than the upper limit pressure and the operating frequency of the inverter reaches the lower limit of the set frequency, it indicates that the

pipeline is overpressured and the inverter can output an alarm signal. This function can be used to determine if the pipeline is blocked. If P4.02 or P4.03 is set to 42, the upper limit pressure alarm will be output.

Function Code	Parameter Name	Setting Range	Minimum Unit	Default	Property
P6.34	Alarm lower limit pressure output	0.001~P6.33 MPa	0.001Mpa	0	○

When the pipe network pressure is lower than the lower limit pressure and the operating frequency of the inverter reaches the upper limit of the set frequency, it indicates that the pipeline is under pressure and the inverter can output an alarm signal. If P4.02 or P4.03 is set to 43, the lower limit pressure alarm will be output.

Function Code	Parameter Name	Setting Range	Minimum Unit	Default	Property
P6.35	Awakening pressure level	0.001~P6.37 MPa	0.001Mpa	0	○

This parameter defines the pressure limit for the system to enter the working state from sleep state.

When the pressure of the pipe network is less than the set value, it indicates that the pressure of the tap water supply decreases or the water consumption increases, and the frequency conversion water supply system automatically switches from the dormant state to the working state.

Function Code	Parameter Name	Setting Range	Minimum Unit	Default	Property
P6.36	Wake-up pressure level continuous time	0.1~6500.0s	0.1s	0	○

This parameter sets the time that the pipe network pressure is continuously maintained at the wake-up pressure level before entering the working state.

Function Code	Parameter Name	Setting Range	Minimum Unit	Default	Property
P6.37	Sleep pressure level	0.001~P6.04 MPa	0.01Mpa	0	○

This parameter defines the pressure limit for the system to enter the sleep state.

When the pipe network pressure is greater than the set value, and the frequency conversion water supply system has been adjusted to sleep frequency operation, it indicates that the actual water consumption is drastically reduced or the tap water supply pressure increases.

At this time, the frequency conversion water supply system automatically enters the dormant state and stops waiting for wake-up .

Function Code	Parameter Name	Setting Range	Minimum Unit	Default	Property
P6.38	Sleep pressure level continuous time	0.1~6500.0s	0.1s	0	○

This parameter sets the time that the pipe network pressure is continuously maintained at the sleep pressure level before entering the sleep state.

Function Code	Parameter Name	Setting Range	Minimum Unit	Default	Property
P6.39	Sleep frequency	0.00Hz~3200.0Hz	0.01Hz	25.00Hz	○

This parameter sets the minimum operating frequency of the inverter before the sleep state.

Function Code	Parameter Name	Setting Range	Minimum Unit	Default	Property
P6.40	Sleep frequency continuous time	0.1~6500.0s	0.1s	0	○

This parameter sets the time that the pipe network pressure is continuously maintained at the sleep pressure level before entering the sleep state.

Function Code	Parameter Name	Setting Range	Minimum Unit	Default	Property
P6.41	Whether sleep frequency participates in hibernation selection (And sleep pressure percentage selection)	00~11	1	00	○

#### Units: Sleep selection

- 0: Sleep frequency condition is valid
- 1: Sleep frequency condition is invalid

#### Ten place: percentage

- 0: Wake up and sleep pressure is the actual pressure;
- 1: Wake up and sleep pressure is a percentage of the set pressure

Function Code	Parameter Name	Setting Range	Minimum Unit	Default	Property
P6.42	Constant pressure water supply blockage judgment time	0.1s~600.0s	0.1s	60.0s	○

## Group P7: Operation Panel and Display

Function Code	Parameter Name	Setting Range	Minimum Unit	Default	Property
P7.00	REV Key function selection	0~4	1	2	○

### 0: RVE key disabled

#### 1: Switchover between operation panel control and remote command control (terminal or communication)

It means switchover from the current command source to the keyboard control (local operation). If the current command source is keyboard control, the function of the key is invalid.

#### 2: Switchover between forward rotation and reverse rotation

The direction of the frequency reference can be changed by REV Key.

Please note it that it's valid only when the current command source is keyboard control.

#### 3: Forward JOG

Forward JOG (FJOG) operation by press REV Key

#### 4: Reverse JOG

Reverse JOG (RJOG) operation by press REV Key

Function Code	Parameter Name	Setting Range	Minimum Unit	Default	Property
P7.01	STOP Key function	0~1	1	1	○

### 0: STOP key enabled only in operation panel control

#### 1: STOP key enabled in any operation mode

Function Code	Parameter Name	Setting Range	Minimum Unit	Default	Property
P7.02	LED display running parameters 1	0000~FFFF	1	001F	○
P7.03	LED display running parameters 2	0000~FFFF	1	0000	○

The parameters are used to set the parameters that can be viewed when the inverter is in the running state. There are maximum 32 running state parameters that can be displayed according to the binary value of each bit in P7.02 and P7.03. The sequence starts from the lowest bit of P7.02.

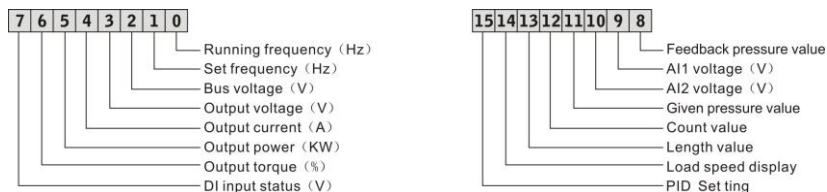

Fig.6-29 P7.02 unit's definition

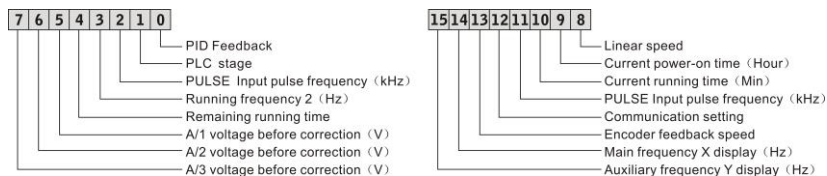

Fig.6-30 P7.03 unit's definition

Function Code	Parameter Name	Setting Range	Minimum Unit	Default	Property
P7.04	LED display stop parameters	0000~FFFF	1	0033	○

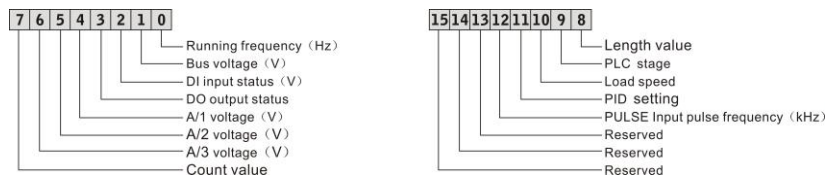

Fig.6-31 P7.04 unit's definition

Function Code	Parameter Name	Setting Range	Minimum Unit	Default	Property
P7.05	Load speed display coefficient	0.0001~6.5000	0.0001	1.0000	*

The parameter is used to adjust the relationship between the output frequency of the inverter and the load speed. For more function details, please refer to the description of P7.11.

Function Code	Parameter Name	Setting Range	Minimum Unit	Default	Property
P7.06	Heatsink temperature of inverter module	0.0°C~100.0°C	0.1°C	000	*

It displays the IGBT temperature of the inverter. Different type inverter has different IGBT overheat protection value.

Function Code	Parameter Name	Setting Range	Minimum Unit	Default	Property
P7.07	Product number	0.00~10.00	0.01	-	*
P7.08	Accumulative running time	0H~65535h	1	000	*

It displays the accumulative running time of the AC drive. After the accumulative running time reaches the value set in P2.17, the terminal with the digital output function 12 becomes ON.

Function Code	Parameter Name	Setting Range	Minimum Unit	Default	Property
P7.09	Software version 1	0.00~10.00	0.01	9000	*
P7.10	Software version 2	0.00~10.00	0.01	0.55	*

It displays the software version.

Function Code	Parameter Name	Setting Range	Minimum Unit	Default	Property
P7.11	Number of decimal places for load speed display	10~23	1	1	○

**Unit's digit: Number of decimal places for b0.14**

**0: 0 decimal place**

**1: 1 decimal place**

**2: 2 decimal place**

**3: 3 decimal place**

P7.11 is used to set the number of decimal places for load speed display. The following gives an example to explain how to calculate the load speed:

Assume that P7.05 (Load speed display coefficient) is 2.000 and P7.11 is 2 (2 decimal places). When the running frequency of the AC drive is 40.00 Hz, the load speed is  $40.00 * 2.000 = 80.00$  (display of 2 decimal places).

If the AC drive is in the stop state, the load speed is the speed corresponding to the set frequency, namely, "set load speed". If the set frequency is 50.00 Hz, the load speed in the stop state is  $50.00 * 2.000 = 100.00$  (display of 2 decimal places).

Function Code	Parameter Name	Setting Range	Minimum Unit	Default	Property
P7.12	Accumulative power-on time	0h~65535h	1	000	○

It is used to display the accumulative power-on time of the AC drive since the delivery.

If the time reaches the set power-on time (P2.16), the terminal with the digital output function 24 becomes ON.

Function Code	Parameter Name	Setting Range	Minimum Unit	Default	Property
P7.13	Accumulative power consumption	0~65535 KWh	1	0KWh	○

It displays the accumulative power consumption of the AC drive until now.

## Group P8: Motor Parameters

Function Code	Parameter Name	Setting Range	Minimum Unit	Default	Property
P8.00	Motor type selection	0~1	1	0	×
P8.01	Rated motor power	0.1KW~1000.0KW	0.1KW	Model depend	×
P8.02	Rated motor voltage	1V~2000V	1V	Model depend	×
P8.03	Rated motor current	0.01A~655.35A ( inverter powers≤55KW) 0.1A~6553.5A(inverter power >55KW)	0.01A	Model depend	×



Function Code	Parameter Name	Setting Range	Minimum Unit	Default	Property
P8.04	Rated motor frequency	0.01Hz to maximum frequency	0.01Hz	Model depend	×
P8.05	Rated motor rotational speed	1rpm~65535rpm	1rpm	Model depend	×

To ensure the control performance, please set the values of P8.01~ P8.05 correctly according to the motor nameplate parameters. The motor and inverter power levels should be matched. Generally, the motor power allowed to be two grade smaller than the inverter power or one grade larger. If it exceeds the range, the control performance cannot be guaranteed. To obtain better VF or vector control performance, motor parameter auto-tuning is required. The accuracy of the adjustment result is closely related to the correct setting of the motor nameplate parameters.

Function Code	Parameter Name	Setting Range	Minimum Unit	Default	Property
P8.06	Stator resistance (asynchronous motor)	0.001Ω~65.535Ω(inverter power≤55KW) 0.0001Ω~6.5535Ω(inverter power>55KW)	0.001Ω	Tuning parameter	×
P8.07	Rotor resistance (asynchronous motor)	0.001Ω~65.535Ω(inverter power≤55KW) 0.0001Ω~6.5535Ω(inverter power>55KW)	0.001Ω	Tuning parameter	×
P8.08	Leakage inductive reactance (asynchronous motor)	0.01mH~655.35mH(inverter power≤55KW) 0.001mH~65.535mH(inverter power>55KW)	0.01mH	Tuning parameter	×
P8.09	Mutual inductive reactance (asynchronous motor)	0.01mH~6553.5mH(inverter power≤55KW) 0.01mH~655.35mH(inverter power>55KW)	0.1mH	Tuning parameter	×
P8.10	No-load current (asynchronous motor)	0.01A~P8.03(inverter power≤55KW) 0.01A~P8.03(inverter power>55KW)	0.01	Tuning parameter	×

The parameters in P8.06 to P8.10 are asynchronous motor parameters. These parameters are unavailable on the motor nameplate and are obtained by means of motor auto-tuning. Only P8.06 to P8.08 can be obtained through static motor auto-tuning. Through complete motor auto-tuning, encoder phase sequence and current loop PI can also be obtained besides the parameters in P8.06 to P8.10.

When motor rated power (P8.01) or motor rated voltage (P8.02) is changed, the AC drive

automatically restores values of P8.06 to P8.10 to the parameter setting for the common standard Y series asynchronous motor.

Function Code	Parameter Name	Setting Range	Minimum Unit	Default	Property
P8.27	Encoder pulses per revolution	0~65535	1	1024	x

This parameter is used to set the pulses per revolution (PPR) of ABZ or UVW incremental encoder. In Close-loop mode, the motor cannot run properly if the parameter is set incorrectly.

Function Code	Parameter Name	Setting Range	Minimum Unit	Default	Property
P8.28	Encoder type	0~4	1	0	x

**0: ABZ incremental encoder**

**1: UVW incremental encoder**

**2: Rotary transformer**

**3: SIN/COS encoder**

**4: Wire-saving UVW encoder**

NE900 supports multiple types of encoder. Different PG cards are required for different types of encoder. Select the PG card correctly when using encoder. Generally, only ABZ incremental encoder and resolver are applicable to asynchronous motor.

After installation of the PG card well, set P8.28 correctly according to the actual condition. Otherwise, the AC drive may cannot run normally.

Function Code	Parameter Name	Setting Range	Minimum Unit	Default	Property
P8.29	Reserved	-	-	-	x

Reserved.

Function Code	Parameter Name	Setting Range	Minimum Unit	Default	Property
P8.30	A,B phase sequence of ABZ incremental encoder	0~1	1	0	x

**0: Forward**

**1: Reverse**

The parameter is valid only for ABZ incremental encoder ( P8.28 = 0).It's used to set the AB signal phase sequence of the ABZ incremental encoder.The AB signal phase sequence of the ABZ incremental encoder can be obtained after motor complete auto-tuning.

Function Code	Parameter Name	Setting Range	Minimum Unit	Default	Property
P8.34	Number of pole pairs of rotary transformer	0~65535	1	1	x

If a resolver is applied, set the number of pole pairs properly.

Function Code	Parameter Name	Setting Range	Minimum Unit	Default	Property
P8.37	Auto-tuning selection	0~12	1	0	x

## 0: No auto-tuning

### 1: Asynchronous motor static auto-tuning

It is applicable to scenarios where complete auto-tuning cannot be performed because the asynchronous motor cannot be disconnected from the load. Before performing static auto-tuning, properly set the motor type and motor nameplate parameters of P8.00 to P8.05 first. The AC drive will obtain parameters of P8.06 to P8.08 by static auto-tuning. Operation instructions: Set the parameter to 1 and press FWD, then the AC drive starts static auto-tuning.

### 2: Asynchronous motor with-load auto-tuning

To ensure the dynamic control performance of the inverter, please select motor complete auto-tuning and make sure the motor is disconnected from the load and in non-load state. During the process of complete auto-tuning, the AC drive performs static auto-tuning first and then accelerates to 80% of the rated motor frequency within the acceleration time set in P0.12. The AC drive keeps running for a certain period and then decelerates to stop within deceleration time set in P0.13.

Before performing complete auto-tuning, properly set the motor type, motor nameplate parameters of P8.00 to P8.05, Encoder type (P8.27) and Encoder pulses per revolution (P8.28) first. The AC drive will obtain motor parameters of P8.06 to P8.10, A/B phase sequence of ABZ incremental encoder (P8.30) and vector control current loop PI parameters of P8.14 to P8.17 by complete auto-tuning. Operation instructions: Set the parameter to 2 and press RUN, then the AC drive starts complete auto-tuning.

### 11: Synchronous machine static self-learning

### 12: Synchronous machine dynamic self-learning

## Group P9: Vector Control Parameters

Function Code	Parameter Name	Setting Range	Minimum Unit	Default	Property
P9.00	Speed/Torque control mode	0~1	1	0	×

### 0: Speed control

#### 1: Torque control

The NE900 provides X terminals with two torque related functions, function 29 (Torque control prohibited) and function 46 (Speed control/Torque control switchover). The two X terminals need to be used together with P9.00 to implement speed control/torque control switchover.

If the X terminal allocated with function 46 (Speed control/Torque control switchover) is OFF, the control mode is determined by P9.00. If the X terminal allocated with function 46 is ON, the control mode is reverse to the value of P9.00.

However, if the X terminal with function 29 (Torque control prohibited) is ON, the AC drive is fixed to run in the speed control mode.

Function Code	Parameter Name	Setting Range	Minimum Unit	Default	Property
P9.01	Speed loop proportional gain 1	1~100	1	30	○
P9.02	Speed loop integral time 1	0.01s~10.00s	0.01s	0.50s	○
P9.03	Switchover frequency 1	0.00~P9.06	0.01Hz	5.00Hz	○
P9.04	Speed loop proportional gain 2	1~100	1	20	○
P9.05	Speed loop integral time 2	0.01s~10.00s	0.01s	1.00s	○
P9.06	Switchover frequency 2	P9.02~Maximum frequency	0.01Hz	10.00Hz	○

It can select different speed loop PI parameters when the inverter runs at different frequencies. When the running frequency is less than the switchover frequency 1 (P9.03), the speed loop PI adjustment parameters are P9.01 and P9.02. When the running frequency is greater than the switchover frequency 2, the speed loop PI adjustment parameters are P9.04 and P9.05. The speed loop PI parameteres is linearly switched by two groups of PI parameters when it's between the switchover frequency 1 and the switchover frequency 2, as shown in Figure 6-32:

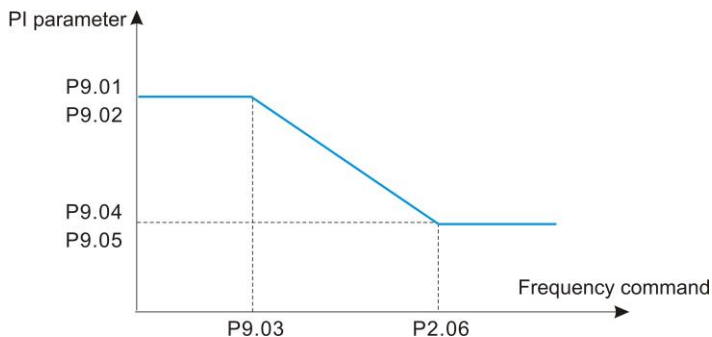

Fig. 6-32 PI parameters relationship diagram

The speed dynamic response characteristics in vector control can be adjusted by setting the proportional gain and integral time of the speed regulator.

To achieve a faster system response, please increase the proportional gain and reduce the integral time. But too large value may lead to system oscillation.

The recommended adjustment method is as follows: If the factory setting cannot meet the requirements, please make proper adjustment base on the factory default. Increase the proportional gain first to ensure that the system does not oscillate, and then reduce the integral time to ensure that the system has quick response and small overshoot.

**NOTE:** Improper PI parameter setting may cause too large speed overshoot or overvoltage fault may even occur when the overshoot drops.

Function Code	Parameter Name	Setting Range	Minimum Unit	Default	Property
P9.07	Vector control slip gain	50%~200%	0.01%	100%	○

For SVC control, it is used to adjust speed stability accuracy of the motor. When the motor with load runs at a very low speed, increase the value of the parameter and vice versa.

For close-loop vector control, it is used to adjust the output current of the AC drive with same load.

Function Code	Parameter Name	Setting Range	Minimum Unit	Default	Property
P9.08	Speed loop filtering time constant	0.000s~0.100s	0.001s	0.028s	○

In vector control mode, the output of the speed loop regulator is torque current reference. The parameter is used to filter the torque references and no need be adjusted generally. Please increase it properly when large speed fluctuation occurs. In the case of motor oscillation, please decrease the parameter value properly.

If the parameter value is small, the output torque of the AC drive may fluctuate greatly, but the response is quick.

Function Code	Parameter Name	Setting Range	Minimum Unit	Default	Property
P9.09	Vector control over-excitation gain	0~200	1	64	○

During deceleration of the AC drive, over-excitation control can restrain the rise of the DC bus voltage and avoid the overvoltage fault. The larger the over-excitation gain, the better the restraining effect.

Please increase the over-excitation gain if the AC drive is easy to occur overvoltage error during deceleration. But too large over-excitation gain may lead to an increasing of output current. Therefore, set the parameter to a proper value in actual applications.

For the applications with small inertia (the bus voltage will not rise during deceleration) or where there is a braking resistor, please set the over-excitation gain as 0.

Function Code	Parameter Name	Setting Range	Minimum Unit	Default	Property
P9.10	Torque upper limit source in speed control mode	0~7	1	0	○
P9.11	Digital setting of torque upper limit in speed control mode	0.0%~200.0%	0.1%	150.0%	○

#### 0: P9.11 setting

1: VI

2: CI

4: Pulse setting

5: Communication setting

6: MIN(VI, CI)

7: MAX(VI, CI)

In speed control mode, the maximum torque output of the AC drive is controlled by the torque upper limit source. P9.10 is used to select the torque upper limit source.

If the torque upper limit is analog, pulse or communication setting, 100% of the setting corresponds to the value of P9.11 and the value 100% of P9.11 corresponds to the AC drive rated torque.

Please refer to the description of the AI curves in P3 group for VI, CI and WI setting.

For details about pulse setting, please refer to the description of P3.32 to P3.35.

When it's communication setting, the host computer writes data -100.00% to 100.00% by the communication address 0x1000, where 100.0% corresponds to the value of P9.11.

Function Code	Parameter Name	Setting Range	Minimum Unit	Default	Property
P9.12	Torque upper limit source in speed control(stop) mode	0~7	1	0	○
P9.13	Digital setting of torque upper limit in speed control(stop) mode	0.0%~200.0%	0.1%	150.0%	○

#### 0: Function code P9.12 setting

1: VI

2: CI

3: Reserved

4: Pulse setting

5: Communication setting

6: MIN(VI, CI)

7: MAX(VI, CI)

Options 1~7 full range corresponds to P9.12.

Function Code	Parameter Name	Setting Range	Minimum Unit	Default	Property
P9.14	Excitation adjustment proportional gain	0~60000	1	2000	○
P9.15	Excitation adjustment integral gain	0~60000	1	1300	○
P9.16	Torque adjustment proportional gain	0~60000	1	2000	○
P9.17	Torque adjustment integral gain	0~60000	1	1300	○

These parameters are current loop PI parameters for vector control. They obtained through asynchronous motor complete auto-tuning automatically and no need to be modified.

Please note that the dimension of the current loop integral regulator is integral gain rather than integral time. Too large current loop PI gain may lead to oscillation of the entire control loop. Therefore, when current oscillation or torque fluctuation is great, manually decrease the proportional gain or integral gain here.

Function Code	Parameter Name	Setting Range	Minimum Unit	Default	Property
P9.21	Over-modulation coefficient	100%~110%	1%	105%	×

The maximum output voltage coefficient indicates the lifting capacity of the maximum output voltage of the inverter. Increasing P9.21 can increase the maximum load capacity of the weak field of the motor, but it will also increase the motor ripple current and increase the heat generated by the motor. The maximum capacity of the weak field of the motor will decrease when decrease the coefficient. The motor ripple current and the heat generated by the motor will also decrease. Generally the coefficient no need to be adjusted.

Function Code	Parameter Name	Setting Range	Minimum Unit	Default	Property
P9.22	Max torque coefficient of excitation area	50%~200%	1%	100%	○

The parameter only takes effect when the motor is running above the rated frequency. Please reduce P9.22 appropriately when the motor needs to accelerate to 2 times of the rated motor frequency and the actual acceleration time is long. When the motor runs at 2 times the rated frequency and the speed drops sharply, please increase P9.22 appropriately. Generally it no need to change.

Function Code	Parameter Name	Setting Range	Minimum Unit	Default	Property
P9.24	Driving torque upper limit source	0~7	1	0	○
P9.26	Digital setting of torque upper limit in torque control mode	-200.0%~200.0%	0.1%	150.0%	○

For details of the parameters function and setting, please refer to P9.10 (P9.24) and P9.11 (P9.26).

Function Code	Parameter Name	Setting Range	Minimum Unit	Default	Property
P9.28	Maximum forward frequency in torque control mode	0.00Hz~Maximum frequency	0.01Hz	50.00Hz	○
P9.29	Maximum reverse frequency in torque control mode	0.00Hz~Maximum frequency	0.01Hz	50.00Hz	○



The parameters used to set the forward and reverse maximum running frequency of the inverter under the torque control mode. In torque mode, if the load torque is less than the motor output torque, the motor speed will continue to rise. To prevent accidents such as flying in the mechanical system, the maximum motor speed during torque control must be limited. You can control the upper limit frequency when you need to achieve dynamic continuous change of maximum frequency in torque control.

Function Code	Parameter Name	Setting Range	Minimum Unit	Default	Property
P9.30	Acceleration time of torque control	0.00s~65000s	0.01s	50.00Hz	○
P9.31	Deceleration time of torque control	0.00s~65000s	0.01Hz	50.00Hz	○

In torque control, the difference between the motor output torque and the load torque determines the speed change rate of the motor and load. The motor rotational speed may change quickly and it will result in noise or too large mechanical stress. The setting of acceleration/deceleration time in torque control makes the motor rotational speed change softly.

However, in applications requiring rapid torque response, please set the acceleration/deceleration time in torque control to 0.00s.

## Group PA: Fault and Protection

Function Code	Parameter Name	Setting Range	Minimum Unit	Default	Property
PA.00	Motor overload protection selection	0~1	0	1	○

### 0: Disabled

The motor overload protective function is disabled and the motor is exposed to potential damage due to overheating. Thermal relay is suggested to be installed between the AC drive and the motor.

### 1: Enabled

The inverter judges whether the motor is overloaded according to the inverse time-lag curve of the motor overload protection.

Function Code	Parameter Name	Setting Range	Minimum Unit	Default	Property
PA.01	Motor overload protection gain	0.20~10.001	0.001	0.001	○

The inverse time-lag curve of the motor overload protection is:  $220\% \times PA.01 \times \text{motor rated current}$  (if the load remains at the value for one minute, the AC drive reports motor overload fault), or  $150\% \times PA.01 \times \text{motor rated current}$  (if the load remains at the value for 60 minutes, the AC drive reports motor overload fault).

**Note:**

Set PA.01 properly based on the actual overload capacity. If the value of PA.01 is set too large, it will lead to the motor damage when the motor overheat but the AC drive does not report the alarm.

Function Code	Parameter Name	Setting Range	Minimum Unit	Default	Property
PA.02	Motor overload protection coefficient	50%~100%	1%	80%	○

The function is used to give a warning signal to the control system via DO before motor overload protection. The parameter is used to determine the percentage at which pre-warning is performed before motor overload. The larger the value is, the less advanced the pre-warning will be.

When the accumulative output current of the AC drive is greater than the value of the overload inverse time-lag curve multiplied by PA.02, the DO terminal on the AC drive allocated with function 6 (Motor overload pre-warning) becomes ON.

Function Code	Parameter Name	Setting Range	Minimum Unit	Default	Property
PA.03	Overvoltage stall gain	0~100	1	0	○
PA.04	Overvoltage stall protection voltage	120%~150%	1%	130%	○

During the deceleration operation of the inverter, due to the influence of load inertia, the actual rate of decline of the motor speed may be lower than the rate of decrease of the output frequency. At this time, the motor will feed back power to the inverter which will causing the DC bus voltage of the inverter to rise. If no measures are taken, an overvoltage trip will occur.

If the overvoltage stall gain is set to 0, the overvoltage stall function is disabled.

The overvoltage stall protection function detects the bus voltage during the deceleration operation of the inverter and compares it with the stall overvoltage point set by the stall prevention voltage. If the stall prevention voltage is exceeded, the inverter output frequency

stops decreasing, when the bus voltage is detected again lower than the stall prevention voltage, the deceleration operation is performed, as shown in Fig.6-33.

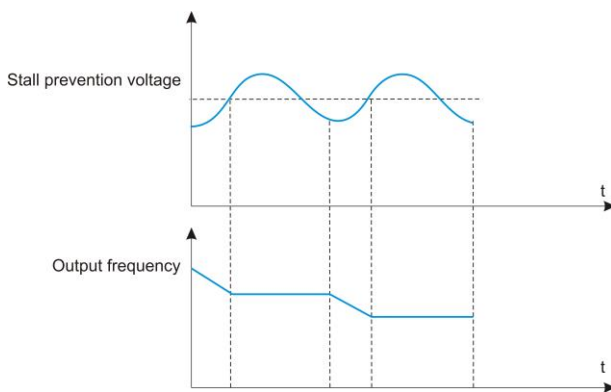

Figure 6-33 Over voltage stall function

Function Code	Parameter Name	Setting Range	Minimum Unit	Default	Property
PA.05	Overvoltage stall gain	0~100	-	20	○
PA.06	Overvoltage stall protection current	100%~200%	-	150%	○

During the acceleration and deceleration of the inverter, when the output current exceeds the stall prevention current, the inverter stops the acceleration and deceleration process, keeps at the current running frequency, and continues to accelerate a

nd decelerate after the output current drops.

Stall prevents current gain and is used to adjust the ability of the inverter to stall during acceleration and deceleration. The larger the value, the stronger the overcurrent capability is suppressed. The smaller the gain setting, the better, without overcurrent.

For a small inertia load, the stall prevention current gain should be small, otherwise the system dynamic response will be slow. For large inertia loads, this value should be large, otherwise the suppression effect is not good and overcurrent faults may occur.

When the overrun speed gain is set to 0, the current stall prevention function is canceled.

Function Code	Parameter Name	Setting Range	Minimum Unit	Default	Property
PA.05	Overvoltage stall gain	0~100	-	20	○
PA.06	Overvoltage stall protection current	100%~200%	-	150%	○

During the acceleration and deceleration of the inverter, when the output current exceeds the stall prevention current, the inverter stops the acceleration and deceleration process, keeps at the current running frequency, and continues to accelerate and decelerate after the output current drops.

Stall prevents current gain and is used to adjust the ability of the inverter to stall during acceleration and deceleration. The larger the value, the stronger the overcurrent capability is suppressed. The smaller the gain setting, the better, without overcurrent.

For a small inertia load, the stall prevention current gain should be small, otherwise the system dynamic response will be slow. For large inertia loads, this value should be large, otherwise the suppression effect is not good and overcurrent faults may occur.

When the overrun speed gain is set to 0, the current stall prevention function is canceled.

Function Code	Parameter Name	Setting Range	Minimum Unit	Default	Property
PA.09	Fault auto reset times	0~20	-	0	○
PA.10	DO action during fault auto reset	0~1	-	0	○
PA.11	Time interval of fault auto reset	0.1s~100.0s	-	10S	○

When the inverter selects fault automatic reset, it can be automatically reset by PA.09. After this number of times, the inverter remains in a fault state.

If the inverter is set to the fault auto reset function, the fault DO output will be activated during the fault auto reset, which can be set by PA.10.

#### 0: Invalid

#### 1: Valid

The waiting time from the inverter fault alarm to the automatic fault reset can be set by PA.11.

Function Code	Parameter Name	Setting Range	Minimum Unit	Default	Property
PA.12	Motor overload warning coefficient	00-11	-	11	○

**Single digit: Enter the missing phase for protection selection.**

**0: Input phase loss protection is prohibited**

**1: Allow input phase loss protection**

**ten digits: contactor suction protection option.**

**0: Pull-in is not protected**

**1: suction protection**

Function Code	Parameter Name	Setting Range	Minimum Unit	Default	Property
PA.13	Output phase loss protection option	0-1		1	○

Choose whether to protect the output phase loss.

**0: Disable output phase loss protection**

**1: Allow output phase loss protection**

Function Code	Parameter Name	Setting Range	Minimum Unit	Default	Property
PA.14	First failure type	0~E-35		0	○
PA.15	Second failure type	0~E-35		0	○
PA.16	Third (most recent) fault type	0~E-35		10S	○

Record the last three fault types of the inverter, 0 is no fault. For the possible causes and solutions of each fault code, please refer to the relevant instructions in Chapter 7.

Function Code	Parameter Name	Setting Range	Minimum Unit	Default	Property
PA.17	Frequency upon 3rd fault	-	-	-	*
PA.18	Current upon 3rd fault	-	-	-	*
PA.19	Bus voltage upon 3rd fault	-	-	-	*
PA.20	Input terminal status upon 3rd fault	-	-	-	*
PA.21	Output terminal status upon 3rd fault	-	-	-	*
PA.22	AC drive status upon 3rd fault	-	-	-	*
PA.23	Power-on time upon 3rd fault	-	-	-	*
PA.24	Running time upon 3rd fault	-	-	-	*

The state of the digital input terminal in the most recent fault, the order is: BIT9 ~ BIT0

---

correspond to X10~X1 respectively.

When the input terminal is ON, its corresponding secondary system is 1, and OFF is 0. The status of all DIs is converted to decimal display.

The status of all output terminals in the most recent fault is BIT4-DO2, BIT3-DO1, BIT2-REL2, BIT1-REL1, BIT0-FM.

When the output terminal is ON its corresponding binary bit is 1. OFF is 0, and all output terminal states are converted to decimal numbers.

Function Code	Parameter Name	Setting Range	Minimum Unit	Default	Property
PA.25	Frequency upon 2nd fault	-	-	-	*
PA.26	Current upon 2nd fault	-	-	-	*
PA.27	Bus voltage upon 2nd fault	-	-	-	*
PA.28	Input terminal status upon 2nd fault	-	-	-	*
PA.29	Output terminal status upon 2nd fault	-	-	-	*
PA.30	AC drive status upon 2nd fault	-	-	-	*
PA.31	Power-on time upon 2nd fault	-	-	-	*
PA.32	Running time upon 2nd fault	-	-	-	*

PA.25~ PA.32 are the second fault information, and the corresponding relationship is the same as PA.17~ PA.24.

Function Code	Parameter Name	Setting Range	Minimum Unit	Default	Property
PA.33	Frequency upon 1st fault	-	-	-	*
PA.34	Current upon 1st fault	-	-	-	*
PA.35	Bus voltage upon 1st fault	-	-	-	*
PA.36	Input terminal status upon 1st fault	-	-	-	*
PA.37	Output terminal status upon 1st fault	-	-	-	*
PA.38	AC drive status upon 1st fault	-	-	-	*
PA.39	Power-on time upon 1st fault	-	-	-	*
PA.40	Running time upon 1st fault	-	-	-	*

PA.33~ PA.40 are the second fault information, and the corresponding relationship is the same as PA.17~ PA.24.

Function Code	Parameter Name	Setting Range	Minimum Unit	Default	Property
PA.43	Fault protection action selection 1	00000-22222	11111	00000	*
PA.44	Fault protection action selection 2	00000-22222	11111	00000	*
PA.45	Fault protection action selection 3	00000-22222	11111	00000	*
PA.46	Fault protection action selection 4	00000-22222	11111	00000	*

The protection actions of the inverter in the following abnormal states can be selected by function codes PA.43, PA.44, PA.35 and PA.36. The meaning of each bit of each function code is:

**0: Free stop**

**1: Stop by stop mode**

**2: continue to run**

*Table 6-6 Fault protection action selection*

PA.43 fault protection action selection 1	PA.44 fault protection action selection 2
Unit digit: motor overload (E-11); Ten digits: output phase loss (E-12); Hundreds digits: external fault (E-15); Thousands digits: communication anomaly (E-16); 10,000 digits: function code read and write exception (E-17)	Unit digit: input phase loss (E-19); Ten digits: encoder failure (E-21); Hundreds digits: the running time arrives (E-23); Thousands digits: Power-on time arrives (E-24); 10,000: Motor overheating (E-27)
PA.45 fault protection action selection 3	PA.46 fault protection action selection 4
Unit digit: the speed deviation is too large (E-28) 1; Ten digits: motor overspeed (E-29) 2; Hundreds digits: offload (E-31) Thousands digits: Loss of PID feedback at runtime (E-34); 10,000 digits:reserved	Unit digit: User-defined fault 1 (E-32); Ten digits: User-defined fault 2 (E-33);

Function Code	Parameter Name	Setting Range	Minimum Unit	Default	Property
PA.50	Frequency selection for continuing to run upon fault	0~4	1	0	○

**0: Current running frequency**

## 1: Set frequency

## 2: Run Frequency upper limit

## 3: Run Frequency lower limit

## 4: Run Backup frequency upon abnormality

When a fault occurs during the operation of the inverter and the fault is handled in the continuous mode, the inverter displays A-\*\* and runs at the frequency determined by PA.50.

### Prompt:

- (\*\*): The content is determined by the fault. If the fault is output phase loss fault E-12, the inverter displays A-12.

Function Code	Parameter Name	Setting Range	Minimum Unit	Default	Property
PA.51	Backup frequency upon abnormality	0.0%~100.0%	0.001	100.0%	○

When PA.50 selects the abnormal standby frequency to run, the running frequency is set by PA.51, and 100% corresponds to the maximum frequency.

Function Code	Parameter Name	Setting Range	Minimum Unit	Default	Property
PA.52	Reserved	-	-	-	○
PA.53	Motor overheat protection threshold	0°C~200°C	1°C	110°C	○
PA.54	Motor overheat warning threshold	0°C~200°C	1°C	90°C	○
PA.55	Action selection at instantaneous power failure	0~2	1	0	○
PA.56	Action pause judging voltage at instantaneous power failure	80.0%~100.0%	0.01Hz	90.0%	○
PA.57	Voltage rally judging time at instantaneous power failure	0.00s~100.00s	0.01s	0.50s	○
PA.58	Action judging voltage at instantaneous power failure	60.0%~100.0%	0.10%	80.0%	○

In the case of instantaneous power failure or sudden voltage drop, the inverter compensates the DC bus voltage of the inverter by reducing the output speed and reducing the output voltage of the inverter to maintain the inverter running.

If PA.55=1, the inverter will decelerate when the power is suddenly lost or the voltage suddenly drops. When the bus voltage returns to normal, the inverter will accelerate to the set frequency. The basis for determining that the bus voltage is back to normal is that the bus



voltage is normal and the duration is longer than PA.57 sets the time.

If PA.55=2, the inverter will decelerate until it stops when there is an instantaneous power failure or a sudden drop in voltage.

Refer to Figure 6-34 for a detailed transient stop action procedure.

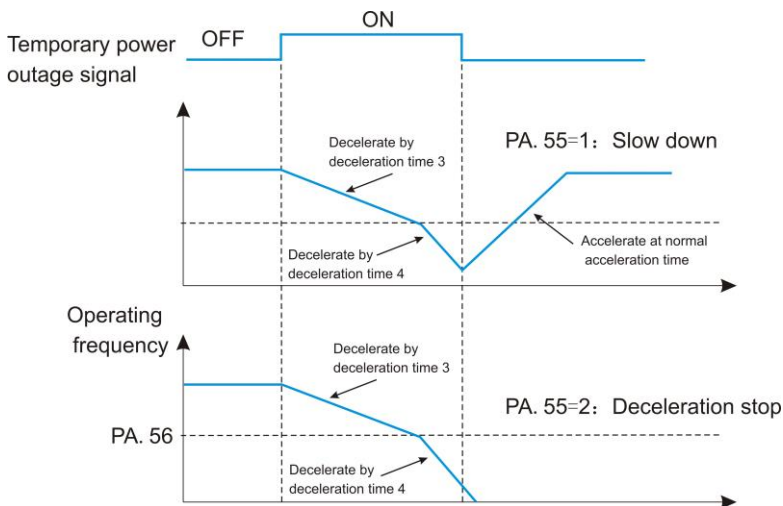

Figure 6-34 Level diagram of the FDT function

Function Code	Parameter Name	Setting Range	Minimum Unit	Default	Property
PA.59	Protection upon load becoming 0	0~1	1	0	○
PA.60	Detection level of load becoming 0	0.0~100.0%	0.001	10.0%	○
PA.61	Detection time of load becoming 0	0.0~60.0s	0.1s	1.0%	○

**0: Disabled**

**1: Enabled**

If the load-shedding protection function is valid, when the output current of the inverter is less than the load detection level PA.60 and the duration is longer than the load detection time PA.61, the inverter output frequency is automatically reduced to 7% of the rated frequency. During load-shedding protection, if the load recovers, the drive automatically resumes to operate at the set frequency.

Function Code	Parameter Name	Setting Range	Minimum Unit	Default	Property
PA.63	Over-speed detection value	0.0%~50.0%	0.1%	20.0%	○
PA.64	Over-speed detection time	0.1~60.0s	0.001	1.0s	○

This function is only available when the drive is running with speed sensor vector control.

When the inverter detects that the actual speed of the motor exceeds the maximum frequency, the excess value is greater than the overspeed detection value PA.63, and the duration is longer than the overspeed detection time PA.64, the inverter fault alarm E-29, and according to the fault protection action Way to handle.

When the overspeed detection time is 0.0s, the overspeed fault detection is canceled.

Function Code	Parameter Name	Setting Range	Minimum Unit	Default	Property
PA.65	Detection value of too large speed deviation	0.0%~50.0%	0.1%	20.0%	○
PA.66	Detection time of too large speed deviation	0.1~60.0s	0.001	5.0s	○

This function is only available when the drive is running with speed sensor vector control.

When the inverter detects that the actual speed of the motor deviates from the set frequency, the deviation is greater than the speed deviation excessive detection value PA.65, and the duration is greater than the speed deviation excessive detection time PA.66, the inverter fault alarm E- 30, and according to the fault protection action mode.

When the speed deviation is too large and the detection time is 0.0s, the speed deviation excessive fault detection is canceled.

## Group Pb: Multi-Reference and Simple PLC Function

The NE900's multi-segment instructions have more functions than the usual multi-speed. In addition to the multi-speed function, it can also be used as a voltage source for VF separation and a given source for process PID. To this end, the dimensions of the multi-segment instructions are relative values.

The simple PLC can complete the simple combination operation of multi-segment instructions.

Function Code	Parameter Name	Setting Range	Minimum Unit	Default	Property
Pb.00~ Pb.15	Multi-segment instruction	-100.0% ~100.0%	0	0.0%	○

Multi-segment instructions can be used in three situations: as a frequency source, as a VF-separated voltage source, as a set source for the process PID.

In three applications, the dimension of the multi-segment instruction is relative value, the range is -100.0%~100.0%, which is the percentage of the relative maximum frequency when used as the frequency source; when it is the VF separation voltage source, it is relative to the rated voltage of the motor. Percentage; since the PID given is originally a relative value, the multi-segment instruction does not require a dimension conversion as a PID setting source.

The multi-segment instruction needs to be switched according to the different states of the multi-function digital X. For details, please refer to the related description of the P3 group.

Function Code	Parameter Name	Setting Range	Minimum Unit	Default	Property
Pb.16	Simple PLC running mode	0~1	0	0	○

#### **0: Stop after inverter runs one cycle**

After the inverter completes a single cycle, it will automatically stop and need to give the running command again to start.

#### **1: Keep final values after inverter runs one cycle**

After the inverter completes a single cycle, it automatically maintains the running frequency and direction of the last segment.

#### **2: Repeat after inverter runs one cycle**

After the inverter completes a cycle, it automatically starts the next cycle until it stops when there is a stop command.

The simple PLC function has two functions: as a frequency source or as a voltage source for VF separation.

Figure 6-35 is a schematic diagram of a simple PLC as a frequency source. When the simple PLC is used as the frequency source, the positive and negative of Pb.00~Pb.15 determine the running direction. If it is negative, the inverter runs in the opposite direction.

As a frequency source, the PLC has three modes of operation, and does not have these three modes as a VF separation voltage source.

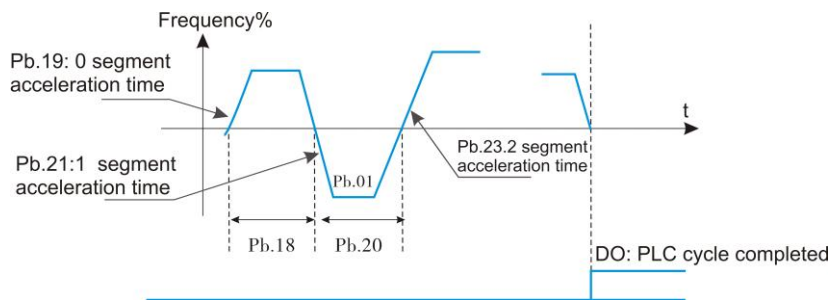

Figure 6-35 Simple PLC schematic

Function Code	Parameter Name	Setting Range	Minimum Unit	Default	Property
Pb.17	Simple PLC retentive selection	00~11	00	11	○

**Unit' s digit: Retentive upon power failure**

**0: NO retentive**

**1: YES**

**Ten' s digit: Retentive upon stop**

**0: NO**

**1: YES**

PLC power-down memory refers to the operating phase and operating frequency of the PLC before the power-down, and continues to run from the memory phase the next time the power is turned on. If you choose not to remember, the PLC process will be restarted every time you power up.

The PLC stop memory records the previous PLC running phase and running frequency when it stops, and continues to run from the memory phase in the next run. If you choose not to remember, the PLC process will be restarted each time you start.

Function Code	Parameter Name	Setting Range	Minimum Unit	Default	Property
Pb.18	Running time of simple PLC reference 0	0.0s(h)~6553.5s(h)	0	0.0s(h)	○
Pb.19	Deceleration time/direction of simple PLC	Units: time selection 0~3 Ten place: direction selection	0	0	○

Function Code	Parameter Name	Setting Range	Minimum Unit	Default	Property
	reference 0	0: forward 1: Reverse			
Pb.20~Pb.46 (even number)	Simple PLC first stage running time	0.0s (h) ~6553.5s (h)	0	0.0s(h)	○
Pb.21~Pb.47 (Odd number)	Deceleration time/direction of simple PLC reference	Units: time selection 0~3 Ten place: direction selection 0: forward 1: Reverse	0	0	○
Pb.48	Running time of simple PLC reference 15	0.0s (h) ~6553.5s (h)	0	0.0s(h)	○
Pb.49	Deceleration time/direction of simple PLC reference 15	Units: time selection 0~3 Ten place: direction selection 0: forward 1: Reverse	0	0	○

Acceleration/deceleration time selection in each segment: 0 to 3 correspond to the 1st to 4th group acceleration/deceleration time.

Function Code	Parameter Name	Setting Range	Minimum Unit	Default	Property
Pb.50	Time unit of simple PLC running	0~1	0	0	○

**0: PA.18 to PA.49 time corresponds to s**

**1: PA.18 to PA.49 time corresponds to h**

Function Code	Parameter Name	Setting Range	Minimum Unit	Default	Property
Pb.51	Multi-reference 0 source	0~7	0	0	○

Detailed function parameter description

**0: Set by PB.00**

**1~3: Analog VI, CI**

**4: Pulse setting**

**5: PID**

**6: Set by preset frequency**

**7: Panel digital setting 2 (save when power off)**

---

This parameter determines the given channel of the multi-segment instruction 0. In addition to PA.00, the multi-segment instruction 0 has a variety of other options to facilitate switching between multi-segment instructions and other given modes. When a multi-segment command is used as a frequency source or a simple PLC as a frequency source, switching between two frequency sources can be easily realized.

## Group PC: Communication Parameter

Please refer to Chapter 9 "NE900 Serial Port RS485 Communication Protocol"

## Group Pd: Function Code Management

Function Code	Parameter Name	Setting Range	Minimum Unit	Default	Property
Pd.00	user password	0~65535	1	0	○

Pd.00 sets any non-zero number, then the password protection function takes effect. The next time you enter the menu, you must enter the password correctly. Otherwise, you cannot view and modify the function parameters. Please remember the user password you set.

Set Pd.00 to 00000 to clear the set user password and invalidate the password protection function.

Function Code	Parameter Name	Setting Range	Minimum Unit	Default	Property
Pd.01	Restore default setting	0~2	1	0	×

### 0: No operation

### 1: Restore factory setting, except motor parameters

After setting Pd.01 to 1, most of the inverter's function parameters are restored to the factory default parameters, but the motor parameters, frequency command decimal point, fault record information, accumulated running time, accumulated power-on time, and accumulated power consumption are not restored.

---

## 2: Clear records

Clear the inverter fault record information, accumulated running time, accumulated power-on time, and accumulated power consumption.

Function Code	Parameter Name	Setting Range	Minimum Unit	Default	Property
Pd.02	Inverter parameter display selection	1~001	1	001	x

**Unit digit:**

**0: Monitoring group b does not display**

**1: Display monitoring group b**

**Ten digits:**

**0: Optimized control parameter group E group is not displayed**

**1: Optimized control parameter group E group display**

Function Code	Parameter Name	Setting Range	Minimum Unit	Default	Property
Pd.04	Parameter modification property	0~1	1	0	o

Whether the user can set the function code parameter can be modified to prevent the danger of the function parameter being mistakenly changed.

When the function code is set to 0, all function codes can be modified; when set to 1, all function codes can only be viewed and cannot be modified.

Function Code	Parameter Name	Setting Range	Minimum Unit	Default	Property
Pd.05	Second row digital LED display	Dual Display Valid	-	-	x

## Group PE: Swing Frequency, Fixed Length and Count

The swing frequency function is suitable for textile, chemical fiber and other industries, as well as occasions requiring traverse and winding functions.

The swing frequency function refers to the inverter output frequency, which swings up and down with the set frequency as the center, and the running frequency is in the time axis.

As shown in Figure 6-36, the swing amplitude is set by PE.00 and PE.01. When PE.01 is set to 0, the swing is 0. At this time, the swing frequency does not work.

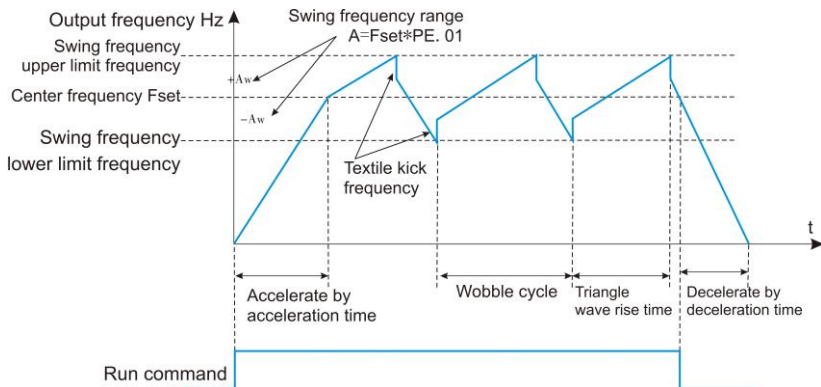

Figure 6-36 Schematic diagram of swing frequency

Function Code	Parameter Name	Setting Range	Minimum Unit	Default	Property
PE.00	Swing frequency setting method	0~1	1	0	○

This parameter is used to determine the reference amount of the swing.

### 0: Relative center frequency (frequency of main reference and auxiliary reference calculation)

For the variable swing system. The swing varies with the center frequency (set frequency).

### 1: Relative maximum frequency (PE.04)

For a fixed swing system, the swing is fixed.

Function Code	Parameter Name	Setting Range	Minimum Unit	Default	Property
PE.01	Swing frequency amplitude	0.0%~100.0%	0.1%	0.0%	○
PE.02	Jump frequency amplitude	0.0%~50.0%	0.1%	0.0%	○



---

This parameter is used to determine the value of the swing value and the kick frequency.

When setting the swing relative to the center frequency (PE.00 = 0), the swing  $AW = \text{primary and secondary frequency given} \times \text{swing amplitude PE.01}$ . When setting the swing relative to the maximum frequency (PE.00 = 1), the swing  $AW = \text{maximum frequency PE.04} \times \text{swing amplitude PE.01}$ .

The amplitude of the kick frequency is the percentage of the frequency of the kick frequency relative to the swing when the swing frequency is running, that is, the burst frequency = swing  $AW \times \text{kick frequency amplitude PE.02}$ . If the swing is selected relative to the center frequency (PE.00 = 0), the burst frequency is the change value. If the swing is selected relative to the maximum frequency (PE.00 = 1), the burst frequency is a fixed value.

The swing frequency is limited by the upper and lower frequencies.

Function Code	Parameter Name	Setting Range	Minimum Unit	Default	Property
PE.03	Swing frequency cycle	0.1s~3000.0s	0.1s	10.0s	○
PE.04	Triangular wave rising time coefficient	0.1s~100.0%	0.1%	50.0%	○

Wobble cycle: The time value of a complete wobble cycle.

The triangular wave rise time coefficient PE.04 is the time percentage of the triangular wave rise time relative to the swing frequency period PE.03.

Triangle wave rise time = swing frequency period PE.03  $\times$  triangle wave rise time coefficient PE.04, in seconds.

Triangular wave fall time = swing frequency cycle PE.03  $\times$  (1-triangular wave rise time coefficient PE.04), in seconds.

Function Code	Parameter Name	Setting Range	Minimum Unit	Default	Property
PE.05	Set length	0m~65535m	1m	1000m	○
PE.06	Actual length	0m~65535m	1m	0m	○
PE.07	Number of pulse per meter	0.1~6553.5	0.1	100.0	○

This set of function codes is used for fixed length control.

The length setting needs to be collected through the multi-function digital input terminal. The number of pulses sampled by the terminal is divided by the number of pulses per meter

PE.07, and the actual length PE.06 can be calculated. When the actual length is greater than the set length PE.05, the multi-function digital DO outputs the "length reached" ON signal.

During the fixed length control, the length reset operation (28 function) can be performed through the multi-function X terminal. For details, please refer to the P3 group.

In the application, the corresponding input terminal function needs to be set to "length count input" (27 function). When the pulse frequency is high, the X5/HDI port must be used.

Function Code	Parameter Name	Setting Range	Minimum Unit	Default	Property
PE.08	Set count value	1~65535	1	1000	○
PE.09	Designated count value	1~65535	1	1000	○

The count value needs to be collected through the multi-function digital input terminal. In the application, the corresponding input terminal function needs to be set to "counter input" (25 function). When the pulse frequency is high, the X5/HDI port must be used.

When the count value reaches the set count value PE.08, the multi-function digital DO outputs the "set count value reached" ON signal, and then the counter stops counting.

When the count value reaches the specified count value PE.09, the multi-function digital DO outputs the "specified count value arrival" ON signal, at which time the counter continues to count until the "set count value" is stopped.

The specified count value PE.09 should not be greater than the set count value PE.08.

Figure 6-37 shows the setting of the arrival of the count value and the arrival of the specified count value.

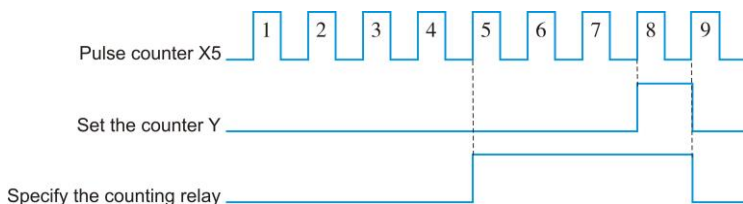

Figure 6-37 Set the count value given and the specified count value given schematic

## Group PF: AI/AO Correction and AI Curve Setting

Function Code	Parameter Name	Setting Range	Minimum Unit	Default	Property
PF.00	VI measured voltage 1	0.500V~4.000V	0.001V	2.000V	○
PF.01	VI sampling voltage 1	0.500V~4.000V	0.001V	2.000V	○
PF.02	VI measured voltage 2	6.000V~9.999V	0.001V	8.000V	○
PF.03	VI sampling voltage 2	6.000V~9.999V	0.001V	8.000V	○

This set of function codes is used to correct the analog input VI to eliminate the effects of zero offset and gain on the AI input.

The function parameters of this group have been corrected at the factory, and will be restored to the factory-corrected value when the factory value is restored. Generally no calibration is required at the application site.

The measured voltage refers to the actual voltage measured by a measuring instrument such as a multimeter. The sampling voltage refers to the voltage display value sampled by the inverter. See the b0 group AI correction voltage (b0.21) display.

During calibration, two voltage values are input to each AI input port, and the value measured by the multimeter and the value read by the b0 group are accurately input into the above function code, and the inverter automatically performs the zero offset of the AI. Correction of the gain.

For the case where the user's given voltage does not match the actual sampling voltage of the inverter, the field calibration method can be used to make the sampling value of the inverter consistent with the expected set value. Taking the port AI as an example, the field calibration method is as follows:

### Given AI voltage signal (about 2V)

The actual measured AI voltage value is stored in the function parameter PF.00. Then check the b0.21 sample value and store it in the function parameter PF.01.

### Given AI voltage signal (about 8V)

Actually measure the AI voltage value and store it in the function parameter PF.03. Check the display value of b0.21 and save it to function parameter PF.04.

Function Code	Parameter Name	Setting Range	Minimum Unit	Default	Property
PF.04	C1 measured voltage 1	0.500V~4.000V	0.001V	2.000V	○

Function Code	Parameter Name	Setting Range	Minimum Unit	Default	Property
PF.05	C1 sampling voltage 1	0.500V~4.000V	0.001V	2.000V	○
PF.06	C1 measured voltage 2	6.000V~9.999V	0.001V	8.000V	○
PF.07	C1 sampling voltage 2	6.000V~9.999V	0.001V	8.000V	○

The function code of this group is corrected with PF.00~PF.03. Sample values are viewed at b0.22.

Function Code	Parameter Name	Setting Range	Minimum Unit	Default	Property
PF.08	----	----	----	----	----
PF.09	----	----	----	----	----
PF.10	----	----	----	----	----
PF.11	----	----	----	----	----

The function code of this group is corrected to PF.00~PF.03. Sample values are viewed at b0.23.

Function Code	Parameter Name	Setting Range	Minimum Unit	Default	Property
PF.12	AO1 ideal voltage 1	0.500V~4.000V	0.001V	2.000V	○
PF.13	AO1 measured voltage 1	0.500V~4.000V	0.001V	2.000V	○
PF.14	AO1 ideal voltage 2	6.000V~9.999V	0.001V	8.000V	○
PF.15	AO1 measured voltage 2	6.000V~9.999V	0.001V	8.000V	○

This set of function codes is used to correct the analog output AO.

The function parameters of this group have been corrected at the factory, and will be restored to the factory-corrected value when the factory value is restored. Generally no calibration is required at the application site.

The ideal voltage is the theoretical output voltage value of the inverter. The measured voltage refers to the actual output voltage measured by an instrument such as a multimeter.

Function Code	Parameter Name	Setting Range	Minimum Unit	Default	Property
PF.16	AO2 ideal voltage 1	0.500V~4.000V	0.001V	2.000V	○
PF.17	AO2 measured voltage 1	0.500V~4.000V	0.001V	2.000V	○

Function Code	Parameter Name	Setting Range	Minimum Unit	Default	Property
PF.18	AO2 ideal voltage 2	6.000V~9.999V	0.001V	8.000V	○
PF.19	AO2 measured voltage 2	6.000V~9.999V	0.001V	8.000V	○

Corrected with AO1.

Function Code	Parameter Name	Setting Range	Minimum Unit	Default	Property
PF.36	VI set jump point	-100.0% ~100.0%	0.001	0%	○
PF.37	VI set jump range	0.0% ~100.0%	0.001	0.5%	○
PF.38	CI set jump point	-100.0% ~100.0%	0.001	0%	○
PF.39	CI set jump range	0.0% ~100.0%	0.001	0.5%	○
PF.40	WI set jump point	-100.0% ~100.0%	0.001	0%	○
PF.41	WI set jump range	0.0% ~100.0%	0.001	0.5%	○

The jump function is to fix the analog amount corresponding set value to the value of the jump point when the analog amount is set to change in the upper and lower sections of the jump point.

For example, the voltage of the analog input AI fluctuates around 5.00V, the fluctuation range is 4.90V~5.10V, the minimum input 0.00V of AI corresponds to 0.0%, and the maximum input 10.00V corresponds to 100.%, then the detected AI corresponds to the setting. It fluctuates between 49.0% and 51.0%.

Set the AI setting jump point PF.36 to 50.0%, and set the AI setting jump width PF.37 to 1.0%. When the AI input is performed, after the jump function processing, the corresponding AI input corresponding setting is fixed to 50.0%. AI is transformed into a stable input that eliminates volatility.

## Group E0: User function code parameter

Function Code	Parameter Name	Setting Range	Minimum Unit	Default	Property
EF.00	PMSM output voltage saturation margin	0%~50%	1%	5%	○
EF.01	PMSM initial position angle detection current	50%~180%	1%	80%	×

Function Code	Parameter Name	Setting Range	Minimum Unit	Default	Property
EF.02	PMSM initial position angle detection	0~2	1	0	○
EF.04	PMSM salient pole rate gain	50~500	1	100	○
EF.05	Maximum torque current ratio control	0~1	0	0	
EF.09	Z signal correction	0~1	1	1	×
EF.10	PMSM SVC initial magnetizing current limit value	0~80%	1%	30%	×
EF.11	PMSM SVC initial minimum carrier frequency	2~P0-15	0.1k	1.5k	×

This set of function codes is a user-defined parameter group.

In all function codes, the user can select the required parameters and summarize them into the E0 group as user-customized parameters for easy viewing and changing operations.

The E0 group provides up to 32 user-customized parameters, and the E0 group parameter display value is uP0.00, indicating that the user function code is empty.

When entering the user-defined parameter mode, the display function code is defined by E0.00~E0.31, and the order is consistent with the E0 group function code, and skipped for P0.00.

## Group E6: Motor parameters

Function Code	Parameter Name	Setting Range	Minimum Unit	Default	Property
E6.00	Synchronous machine field weakening mode	Synchronous machine field weakening mode	1	0	×
E6.01	Synchronous motor field weakening coefficient	Synchronous motor field weakening coefficient	1	0	×
E6.02	Maximum field weakening current	Maximum field weakening current			
E6.03	Field weakening automatic tuning coefficient	Field weakening automatic tuning coefficient			

## Group E9: Protection function parameter

Function Code	Parameter Name	Setting Range	Minimum Unit	Default	Property
E9.00	VF overcurrent operating current	50~200%	50%	150%	○
E9.01	VF over-speed enable	0~1	1	1	○
E9.02	VF overrun speed suppression gain	0~100	20	20	○
E9.03	VF double speed over loss speed action Flow compensation coefficient	50~200%	50%	50%	○

In the high frequency region, the motor drive current is small, and the speed of the motor drops greatly with respect to the same stall current below the rated frequency. In order to improve the operating characteristics of the motor, the stall operating current above the rated frequency can be reduced, in some centrifuges. When the operating frequency is high, requiring several times of weak magnetic field and large load inertia, this method has a good effect on the acceleration performance.

Excessive speed action current exceeding the rated frequency =  $(f_s/f_n) * k * \text{LimitCur}$ ;

$f_s$  is the running frequency,  $f_n$  is the rated frequency of the motor,  $k$  is F3-21 "double speed over loss speed action current compensation coefficient",  $\text{LimitCur}$  is E9.00 "overcurrent speed action current";

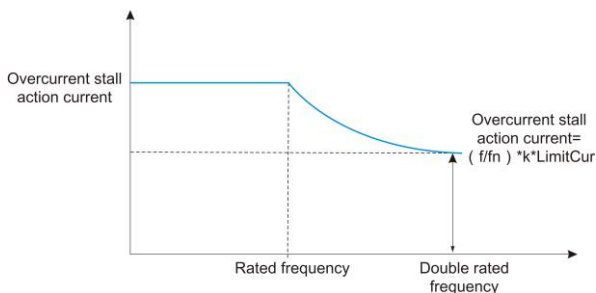

Figure 6-38 Schematic diagram of double speed over loss speed

### Remarks:

Over-current running current 150% means 1.5 times the rated current of the inverter; For high-power motors, the carrier frequency is below 2 kHz. Due to the increase of the ripple current, the wave-by-wave current-limit response starts before the over-speed prevention action, and the torque is insufficient. In this case, reduce the over-speed prevention operation current.

## ● Inverter bus voltage limit (and brake resistor turn-on voltage setting)

If the bus voltage exceeds the overvoltage stall point of 760V, it means that the electromechanical system is already in the power generation state (motor speed > output frequency), the overvoltage stall will work, adjust the output frequency (consuming the excess power), the actual deceleration time will be automatically pulled. Long, avoid trip protection, if the actual deceleration time can not meet the requirements, you can increase the overexcitation gain appropriately.

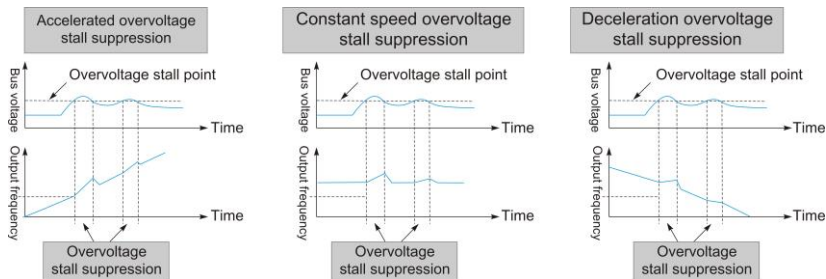

Figure 6-39 Schematic diagram of overvoltage stall action

Function Code	Parameter Name	Setting Range	Minimum Unit	Default	Property
E9.04	Overvoltage stall operating voltage	200.0V~2000.0V	200V	Model determination 220V: 380V 380V: 760V 480V: 850V 690V: 1250V 1140V:1900V	○
E9.05	VF overvoltage stall enable	0~1	1	1	○
E9.06	VF overvoltage stall suppression frequency gain	0~100	1	30	○
E9.07	VF overvoltage stall suppression voltage gain	0~100	1	30	○
E9.08	Overvoltage stall maximum rise limit frequency	0~50Hz	0.1Hz	5Hz	○

### Remarks:

Please note when using a braking resistor or when installing a brake unit or when using an energy feedback unit:

- Please set F3-11 "overexcitation gain" value to "0". If it is not "0", it may cause excessive current during operation.



- Please set F3-23 “Overvoltage stall enable” value to “0”. If it is not “0”, it may cause the deceleration time to prolong.

Function Code	Parameter Name	Setting Range	Minimum Unit	Default	Property
E9.09	Slip compensation time constant	0.1~10.0S	0.1s	0.5s	○

The smaller the response time value of the slip compensation is set, the faster the response speed is.

Function Code	Parameter Name	Setting Range	Minimum Unit	Default	Property
E9.18	Speed tracking closed loop current size	30%~200%	30%	Model determination	○

The maximum current limit of the speed tracking process is within the range of the “speed tracking current” setting. If the set value is too small, the effect of the speed tracking will be worse.

Function Code	Parameter Name	Setting Range	Minimum Unit	Default	Property
E9.21	Demagnetization time	0.0~5.0s	0.1s	Model determination	○

The demagnetization time is the minimum interval between stop and start. This function code will only take effect after the speed tracking function is turned on. If the setting value is too small, it will cause overvoltage fault.

## 2nd, 3rd, and 4th motor parameters (E3, E4, E5 groups)

The E3 group second motor parameters E3.00~E3.37 are the same as the function code group P8.00~P8.37. E3.38~E3.55 are the same function code group P9.01~P9.18.

The third motor parameter E4.00~E4.37 of the E4 group is the same as the function code group P8.00~P8.37. E4.38~E4.55 are the same function code group P9.01~P9.18.

The fourth motor parameter E5.00~E5.37 of E5 group is the same as the function code group P8.00~P8.37. E5.38~E5.55 are the same function code group P9.01~P9.18.

## Monitoring parameter group-operation parameter monitoring (group b0)

See the b0 group parameter description in Chapter 5, “Function Parameter Table”.





## Chapter 7 Fault Diagnosis and Processing

### 7.1 Failure phenomena and countermeasures

When an abnormality occurs in the inverter, the LED digital tube will display the function code and its contents corresponding to the fault. The fault relay will operate and the inverter will stop output. If the motor is rotating, it will stop freely until it stops rotating. The types of faults that may occur on the NE900 are shown in Table 7-1. When the inverter is faulty, the user should first check according to the prompts of the table, and record the fault phenomenon in detail. When technical service is required, please contact our after-sales service and technical support department or our agents.

Error code	Fault type	Cause of issue	Troubleshooting
E-01	The inverter accelerates the overcurrent	The load is too heavy and the acceleration time is too short	Increase acceleration time
		V/F curve is not suitable	Adjust the V/F curve settings.
		Restart the rotating motor	Set to speed detection and restart function
		Torque boost setting is too large	Adjust manual torque boost or change to automatic torque boost
		The inverter power is too small	Use a frequency converter with a large power rating
E-02	Inverter deceleration running over current	Deceleration time is too short	Increase deceleration time
		Potential energy load or large inertia load	Increase the braking power of the external energy brake component
		The inverter power is too small	Use a frequency converter with a large power rating
E-03	Inverter running over current at constant speed	Load mutation	Check load or reduce load mutation
		Acceleration/deceleration time setting is too short	Prolong the acceleration and deceleration time
		Abnormal load	Carry out load check
		Low grid voltage	Check input power
		The inverter power is too small	Use a frequency converter with a large power rating
error code	Fault type	cause of issue	Troubleshooting
E-04	Frequency converter acceleration	Abnormal input voltage	Check input power
		Acceleration time setting is too short	Prolong the acceleration time

<b>Error code</b>	<b>Fault type</b>	<b>Cause of issue</b>	<b>Troubleshooting</b>
	Operating overvoltage...	Restart the rotating motor	Set to speed tracking and restart function
E-05	Inverter deceleration running overvoltage	Deceleration time is too short	Increase deceleration time
		Potential energy load or large inertia load	Increase the braking power of the external energy brake component
E-06	Inverter running at constant speed overvoltage	Abnormal input voltage	Check input power
		Acceleration/deceleration time setting is too short	Prolong the acceleration and deceleration time
		Abnormal change in input voltage	Install input reactor
		Large load inertia	Use energy brake components
E-07	Reserved	---	---
E-08	Inverter overheating	Air duct obstruction	Clean up the air duct or improve ventilation
		Ambient temperature is too high	Improve ventilation and reduce carrier frequency
		Fan damage	Replace the fan
		Inverter module is abnormal	Seeking service
E-09	Inverter overload	Acceleration time is too short	Extended time acceleration
		DC braking is too large	Reduce DC braking current and extend braking time
		V/F curve is not suitable	Adjust V/F curve and torque boost
		Restart the rotating motor	Set to speed detection and restart function
		Grid voltage is too low	Check grid voltage
		Excessive load	Select a higher power inverter
error code	Fault type	cause of issue	Troubleshooting
E-10	Motor overload	V/F curve is not suitable	Adjust V/F curve and torque boost
		Grid voltage is too low	Check grid voltage
		General-purpose motor runs at low speed and large load for a long time	Long-term low speed operation, optional variable frequency motor
		Motor overload protection factor setting is incorrect	Correctly set the motor overload protection factor
		Motor stalled or the load is too large	Check load

Error code	Fault type	Cause of issue	Troubleshooting
E-11	Undervoltage during operation	Grid voltage is too low	Check grid voltage
E-12	Output phase loss	The lead of the inverter to the motor is not normal.	Troubleshoot peripheral faults
		Inverter three-phase output is unbalanced while the motor is running	Check if the three-phase winding of the motor is normal and correct
		The drive board is abnormal	Seek manufacturer or agent service
		Module exception	Seek manufacturer or agent service
		Control panel connection or plug-in loose	Check and reconnect
E-13	External device failure	External fault emergency stop terminal closed	Disconnect external fault terminals after handling external faults
E-14	Current detection circuit failure	Control panel connection or plug-in loose	Check and reconnect
		Auxiliary power supply damage	Seek manufacturer or agent service
		Hall device damage	Seek manufacturer or agent service
		Amplifying circuit abnormal	Seek manufacturer or agent service
error code	Fault type	cause of issue	Troubleshooting
E-15	RS232/485 communication failure	Improper baud rate setting	Set the baud rate appropriately
		Serial port communication error	Press  to reset and seek service
		Improper setting of fault alarm parameters	Modify the settings of P3.09–P3.12
		The host computer is not working	Check if the upper computer works or not, and the wiring is correct.
E-16	System interference	Serious interference	Press  to reset or add on the power input side. Power filter
		Main control board DSP read and write error	Button reset, seek service
E-17	E PROM read and write error	Error in reading and writing control parameters	Press  to reset Seek manufacturer or agent service
E-18	Motor parameter self-learning overcurrent fault	The motor does not match the inverter power segment	Press  to reset Seek manufacturer or agent service

Error code	Fault type	Cause of issue	Troubleshooting
E-19	Input phase loss protection	R, S, T input three phases have one phase without voltage	Press  to reset Check the inverter input R, S, T power supply
E-20	Short circuit protection to ground	Motor short circuit to ground	Replace cable or motor
E-21	Encoder failure	Encoder model does not match	Set the encoder type correctly according to the actual situation.
		Encoder connection error	Troubleshoot the line
		Encoder damage	Replace the encoder
		PG card is abnormal	Replace the PG card
E-22	Control power failure	The input voltage is not within the range specified by the specification.	Adjust the voltage to the extent required by the specification
error code	Fault type	cause of issue	Troubleshooting
E-23	Run time arrival failure	Cumulative running time reaches the set value	Use the parameter initialization function to clear the record information
E-24	Power-on time to failure	Cumulative power-on time reaches the set value	Use the parameter initialization function to clear the record information
E-25	Switching motor failure during operation	Change current motor selection via terminal during inverter operation	After the inverter stops, the motor is switched.
E-26	Wave-by-wave current limiting fault	Whether the load is too large or the motor is blocked	Reduce load and check motor and mechanical conditions
E-27	Motor over temperature fault	Temperature sensor wiring is loose	Detect temperature sensor wiring and troubleshoot
		Motor temperature is too high	Reduce the carrier frequency or take other heat dissipation measures to dissipate the motor
E-28	Speed deviation is too large	Encoder parameter setting is incorrect	Set the encoder parameters correctly
		No parameter identification	Motor parameter identification
		Excessive speed deviation detection parameters PA.65, PA.66 settings are unreasonable	Reasonably set the detection parameters according to the actual situation
E-29	Motor overspeed failure	Encoder parameter setting is incorrect	Set the encoder parameters correctly
		No parameter identification	Motor parameter identification

Error code	Fault type	Cause of issue	Troubleshooting
		Motor overspeed detection parameter setting PA.63, PA.64 setting is unreasonable	Reasonably set the detection parameters according to the actual situation
error code	Fault type	cause of issue	Troubleshooting
E-30	Offload	The inverter running current is less than PA.60	Check if the load is out of or whether the PA.60 and PA.61 parameter settings are in line with the actual operating conditions.
E-31	Runtime PID feedback loss failure	PID feedback is less than the setting value of P6.26	Check the PID feedback signal or set P6.26 to a suitable value
E-32	User-defined fault 1	Input the signal of user-defined fault 1 through multi-function terminal X	Reset operation
E-33	User-defined fault 2	Input the signal of user-defined fault 2 through multi-function terminal X	Reset operation
E-34	Contactor failure	The driver board and power supply are not working properly.	Replace the engine board or power board
		Contactor is not working properly	Replacement contactor
E-35	Short circuit to ground	Motor short to ground	Replace cable or motor

## 7.2 Fault Record Query

This series of inverters records the fault codes that have occurred in the last 3 times. Searching for this information can help you find the cause of the fault. The fault information is all stored in the PA group parameters. Please refer to the keyboard operation method to enter the PA group parameter search information.

## 7.3 Fault reset

To resume normal operation when the inverter fails, you can choose any of the following operations:

- When the fault code is displayed, confirm that you can reset and press;
- Set any of the terminals X1–X10 to the external RESET input (P3.00 P3.09=9) and disconnect it from the COM terminal;

- 
- Cut the power.

### Special Note



Caution

- ◆ The cause of the fault must be thoroughly checked and eliminated before resetting, otherwise it may cause permanent damage to the inverter;
- ◆ If the fault cannot be reset after reset or reset, the cause should be checked. Continuous reset will damage the inverter;
- ◆ Overload and overheat protection should be delayed by 5 minutes.

---

## Chapter 8 Maintenance and Maintenance

### 8.1 Daily maintenance and maintenance

Changes in the operating environment of the inverter, such as the effects of temperature, humidity, smoke, etc., and the aging of components inside the inverter may cause various faults in the inverter. Therefore, during the storage and use, the inverter must be inspected daily and regularly maintained.

**When the inverter is normally turned on, please confirm the following:**

- ◆ Whether the motor has abnormal sound and vibration;
- ◆ Whether the inverter and the motor are abnormally heated;
- ◆ Whether the ambient temperature is too high;
- ◆ Whether the load ammeter is the same as usual;
- ◆ Whether the cooling fan of the inverter is working normally.

### 8.2 Regular maintenance and maintenance

Changes in the operating environment of the inverter, such as the effects of temperature, humidity, smoke, etc., and the aging of components inside the inverter may cause various faults in the inverter. Therefore, during the storage and use, the inverter must be inspected daily and regularly maintained.

#### 8.2.1 Regular maintenance

In order to make the inverter work normally for a long time, it must be regularly maintained and maintained for the service life of the internal electronic components of the inverter. The service life of inverter electronic components varies with the environment in which they are used and the conditions of use. The maintenance period of the inverter as shown in Table 8 is for reference only when the user uses it.

Device name	Standard replacement years
cooling fan	2~3 years
Electrolytic capacitor	4~5 years
A printed circuit board	5~8 years
Fuse	10 years

*Table 8-1 Frequency converter component replacement time*



---

**The above conditions for the replacement of the components of the inverter are as follows:**

- ◆ Ambient temperature: an average of 30 ° C per year.
- ◆ Load factor: 80% or less.
- ◆ Running time: less than 12 hours a day.

### 8.2.2 Regular maintenance

When the inverter is regularly maintained and inspected, be sure to turn off the power. Check that the monitor is not displayed and the main circuit power indicator is off. The contents of the check are shown in Table 8-2.

Check item	Check content	Abnormal countermeasure
Main circuit terminal, control circuit terminal screw	Is the screw loose	Tighten with a screwdriver
heat sink	Is there dust	Blow off with dry compressed air at a pressure of 4~6kg/cm
PCB printed circuit board	Is there dust	Blow off with dry compressed air at a pressure of 4~6kg/cm
cooling fan	Whether there is abnormal sound, abnormal vibration, accumulated time running up to 20,000 hours	Replace the cooling fan
Power component	Is there dust	Blow off with dry compressed air at a pressure of 4~6kg/cm
Aluminum electrolytic capacitors	Whether it is discolored, odor, bubbling	Replace aluminum electrolytic capacitor

*Table 8-2 Periodic inspection contents*

### 8.3 Warranty Description

The company will provide warranty service in the following cases:

- 1) The scope of warranty refers only to the body of the inverter;
- 2) In normal use, the inverter will be faulty or damaged during the warranty period. The company is responsible for the warranty; during the over warranty period, reasonable maintenance costs will be charged;
- 3) During the warranty period, we will charge a certain maintenance fee if: The inverter is not damaged according to the operation steps of the instruction manual;

- 
- ◆ Damage to the inverter due to floods, fires, abnormal voltages, etc.;
  - ◆ Damage to the inverter caused by incorrect connection of the cable;
  - ◆ Damage caused when the frequency converter is used for abnormal functions;
- 4) The service charges are calculated based on actual costs. If there is a contract, it will be handled on the principle of contract priority.

---

# Chapter 9 Serial Port RS485 Communication Protocol

## 9.1 Communication Overview

The company's series of inverters provide users with a common RS485 communication interface for industrial control. The communication protocol adopts the MODBUS standard communication protocol. The inverter can be used as a slave to communicate with the host computer (such as PLC controller and PC) with the same communication interface and using the same communication protocol to realize centralized monitoring of the inverter. Can use a frequency converter as The host computer connects several inverters of the company as slaves through the RS485 interface. To achieve multi-machine linkage of the inverter. The remote control keyboard can also be connected through the communication port. Realize the user's remote operation of the inverter.

The MODBUS communication protocol of this inverter supports the RTU mode. The following is a detailed description of the inverter communication protocol.

## 9.2 Communication Protocol Description

### 9.2.1 Communication Network Mode

(1) The inverter acts as a slave network:

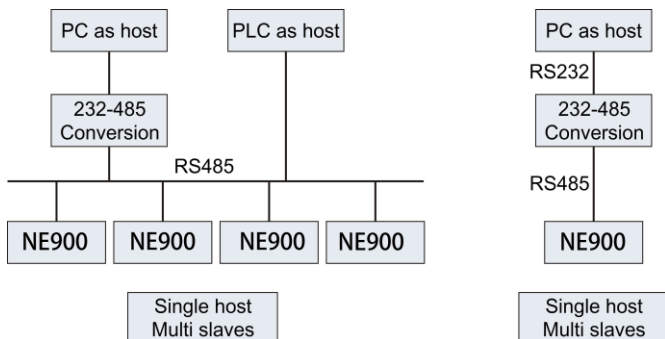
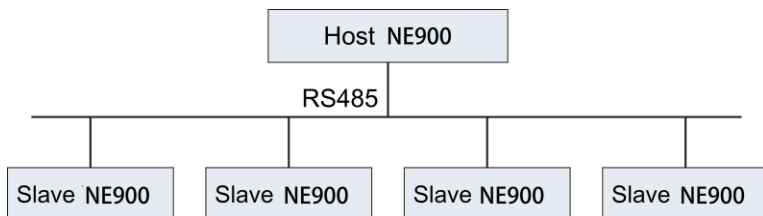

Figure 9-1 Schematic diagram of the unit network

---

(2) Multi-machine linkage networking mode:



*Figure 9-2 Schematic diagram of multi-machine linkage networking*

### 9.2.2 Communication protocol mode

The inverter can be used as a host or as a slave in the RS485 network. When used as a master, it can control other inverters of the company to achieve multi-level linkage. When used as a slave, the PC or PLC can be used as a host. Control the inverter to work. The specific communication methods are as follows:

- ◆ The inverter is a slave, master-slave point-to-point communication. When the host sends a command using the broadcast address, the slave does not answer.
- ◆ As the host, the inverter uses the broadcast address to send commands to the slave, and the slave does not answer.
- ◆ The user can set the local address, baud rate and data format of the inverter by keyboard or serial communication.
- ◆ The slave reports the current fault information in the response frame of the last polling of the host.

### 9.2.3 Communication interface mode

Communication is RS485 interface, asynchronous serial, half duplex transmission. The default communication protocol mode uses RTU mode.

The default data format is: 1 bit start bit, 8 data bits, 2 stop bits, no check.

The default rate is 9600bps. For the communication parameter settings, see PC.00~PC.05 function code.

### 9.3 Communication protocol

Character structure:

11-character box (For RTU)

*(1-8-2 format, no parity)*

Start bit	BIT 0	BIT1	BIT2	BIT3	BIT4	BIT5	BIT6	BIT7	Stop bit	Stop bit
-----------	-------	------	------	------	------	------	------	------	----------	----------

*(1-8-1 format, Odd parity)*

Start bit	BIT 0	BIT1	BIT2	BIT3	BIT4	BIT5	BIT6	BIT7	Odd parity	Stop bit
-----------	-------	------	------	------	------	------	------	------	------------	----------

*(1-8-1 format, Even parity)*

Start bit	BIT 0	BIT1	BIT2	BIT3	BIT4	BIT5	BIT6	BIT7	Even parity	Stop bit
-----------	-------	------	------	------	------	------	------	------	-------------	----------

RTU mode:

START	Keep no input signal greater than or equal to 10ms
Address	Mailing address: 8-bit binary address
Command	Function code: 8-bit binary address
DATA (n - 1)	Data content: N*8-bit data, N<=8, maximum 8 bytes
.....	
DATA 0	
CRC CHK Low	CRC check code
CRC CHK High	16-bit CRC is composed of 2 8-bit binary combinations
END	Keep no input signal greater than or equal to 10ms

The main function of Modbus is to read and write parameters, and different function codes determine different operation requests. The inverter Modbus protocol supports the following function code operations:

function code	Function code definition
0x03	Read inverter function code parameters and running status parameters

function code	Function code definition
0x06	Rewrite a single inverter function code or control parameter, not saved after power failure
0x07	Rewrite a single inverter function code or control parameter, save after power down

The function code parameters, control parameters and status parameters of the inverter are mapped to Modbus read/write registers. The read and write characteristics and range of the function code parameters follow the instructions in the inverter user manual. The control parameters and status parameters of the inverter are separately assigned addresses. The correspondence between the function code group number and its mapped register address high byte is as follows:

- Address 0xF0-0xFF, corresponding to function code parameter group P0-PF;  
For example, to query the parameter P0.03 of the P0 group, the corresponding address is 0xF003;  
For example, to query the parameter P6.10 of the P6 group, the corresponding address is 0xF60A;  
For example, to query the PB.16 parameter of the PB group, the corresponding address is 0xFB10.
- The address 0x500x is the reading address of the inverter status parameters;  
(Note: 0x5000 can be read and written, the subsequent addresses can only be read, not write)
- The address 0x600x is the address of the inverter control parameter group;
- The address 0x8000 is the address of the inverter fault status;
- The address 0x8001 is the abnormal communication address of the inverter (valid when PC.05 = 0);

Inverter status parameter address	Command content	Inverter status parameter address	Command content
0x5000	communication given frequency -10000~1000 (decimal)	0x5011	PID feedback
0x5001	Operating frequency	0x5012	PLC steps
0x5002	Bus voltage	0x5013	PULSE input pulse frequency, unit 0.01KHz
0x5003	Output voltage	0x5014	Feedback speed in 0.1Hz
0x5004	Output current	0x5015	Remaining running time
0x5005	output power	0x5016	AI1 sampling voltage
0x5006	Output torque	0x5017	AI2 sampling voltage

Inverter status parameter address	Command content	Inverter status parameter address	Command content
0x5007	Performance feedback frequency	0x5018	AI3 sampling voltage
0x5008	DI input status	0x5019	line speed
0x5009	DO output status	0x501A	current power-on time
0x500A	AI1 corrected voltage	0x501B	current running time
0x500B	AI2 corrected voltage	0x501C	PULSE input pulse frequency, unit 1Hz
0x500C	AI3 corrected voltage	0x501D	encoder feedback speed 0.01Hz
0x500D	count value input	0x501E	actual feedback speed
0x500E	length value input	0x501F	main frequency X display
0x500F	load speed	0x5020	auxiliary frequency Y display
0x5010	PID setting	-	-

### Control command address

Control word address	Command content	Control word address	Command content
0x6000 (control command word address)	0001: Forward running	0x6001 (communication control analog AO1 output address)	0x0 to 0x7FFF
	0002: Forward running	0x6002 (communication control analog AO2 output address)	0x0 to 0x7FFF
	0003: Forward turning	0x6003 (communication DO output address)	BIT0: DO1 output control
	0004: Reverse jog		BIT1: DO2 output control
	0005: Free stop		BIT2: Relay 1
	0006: Deceleration stop		BIT3: Relay 2
	0007: Fault reset		BIT4: HDD as normal DO output
0x6004 (HDO pulse output system)	0x0 to 0x7FFF		Other bits: reserved

### Prompt:

The communication set value is a percentage of the relative value, 10000 corresponds to 100.00%, and -10000 corresponds to -100.00%.

For frequency dimension data, the percentage is the relative maximum frequency (% of P; for torque dimension data, the percentage is the P9.26 torque upper limit number setting).

0x0~0x7FFF in the AO and HDO outputs are 0%~100 respectively.

Inverter fault address	Inverter fault information	Inverter fault address	Inverter fault information
0x8000	0000: no fault	0x8000	0012: Motor parameter self-learning fault
	0001: Accelerated overcurrent		0013: Input phase loss protection
	0002: Deceleration over current		0014: short circuit to ground
	0003: Constant speed over current		0015: encoder failure
	0004: Accelerated overvoltage		0016: Control power failure
	0005: Deceleration overvoltage		0017: Run time reaches fault
	0006: Constant speed overvoltage		0018: Power-on time reaches fault
	0007: Contactor fault		0019: Switching motor fault during operation
	0008: Inverter overheating		001A: Wave-by-wave current limiting fault
	0009: Inverter overload		001B: Motor over temperature fault
	000A: Motor overload		001C: Speed deviation is too large
	000B: Undervoltage		001D: Motor overspeed failure
	000C: Output phase loss		001E during operation: Offload
	000D: External device failure		001F: Loss of PID feedback during operation
	000E: Current detection circuit fault		0020: User-defined fault 1
	000F: RS232/485 communication failure		0028: User-defined fault 2
0010: System interference	0022: Contactor failure		
0011: E2PROM read and write error	0023: Short to ground		

**Prompt:**

The inverter fault information read by the fault address is consistent with the fault record code data in Table 7-1 of Chapter 7.

If the operation request fails, the response is an error code and an exception code. The address code is 0x8001. The meaning of the exception code is as follows:



Exception code	Exception code meaning	Exception code	Exception code meaning
0x0001	Password error	0x0005	Illegal data, operation data is not in the upper and lower limits, etc.
0x0002	Read and write command error	0x0006	Parameter read-only, no change allowed
0x0003	CRC check error	0x0007	read and write failed, factory parameters are not allowed to operate
0x0004	Illegal address, operation address error	0x0008	Parameter cannot be modified

### CRC check

Considering the need to increase the speed, CRC-16 is usually implemented in a tabular manner. The following is the C source code for implementing CRC-16. Note that the final result has been exchanged for the high and low bytes, that is, the result is the CRC checksum to be sent. .

```
uint16 CrcValueByteCaA0(const uint16 *data, uint16 len)
{
    uint16 CRCValue = 0xFFFF;
    uint16 tmp;
    uint16 a;
    while (len--)
    {
        tmp = *(data++);
        a = (CRCValue ^ tmp) & 0x000F;
        CRCValue >>= 4;
        CRCValue ^= crc16Table[a];
        a = (CRCValue & 0x000F) ^ (tmp >> 4);
        CRCValue >>= 4;
        CRCValue ^= crc16Table[a];
    } return crcValue;
}
```

## Application examples

Read command frame: The request frame is a continuous two parameter values starting from the P0.02 function code of the No. 1 machine.

Address	Command code	Register address	Number of operations bytes	Checksum
0x01	0x03	0x00	0x02	to be calculated

Read command response frame:

Address	Command code	Number of data sections	P0.02 data content		P0.03 data content		Checksum
0x01	0x03	0x04 (2*2)	0x13	0x88	0x00	0x00	to be calculated

Write command frame: The request frame is the data frame of the P0.02 parameter of the No. 1 machine:

Address	Command code	Register address		Write value		Checksum
0x01	0x06	0x00	0x02	0x13	0x88	to be calculated

Write command response frame:

Address	Command code	Register address		Write value		Checksum
0x01	0x06	0x00	0x02	0x13	0x88	to be calculated

Write command frame: No. 1 machine runs forward (requires P0.03 to be 2)

Address	Command code	Register address		Write value		Checksum
0x01	0x06	0x60	0x00	0x00	0x01	to be calculated

## Parameter Description

Function Code	Parameter Name	Setting Range	Minimum Unit	Default	Property
PC.00	Communication baud rate	0~9	1	5	○

- 0: 300BPS
- 1: 600BPS
- 2: 1200BPS
- 3: 2400BPS
- 4: 4800BPS
- 5: 9600BPS
- 6: 19200BPS
- 7: 38400BPS
- 8: 57600BPS
- 9: 115200BPS

This parameter is used to set the data transmission rate between the host computer and the inverter. Note that the baud rate set by the host computer and the inverter must be the same. Otherwise, the communication cannot be performed.

Function Code	Parameter Name	Setting Range	Minimum Unit	Default	Property
PC.01	MODBUS data format	0~3	1	0	○

- 0: No parity: data format <8, N, 2>
- 1: Even check: data format <8, E, 1>
- 2: Odd parity: data format <8, O, 1>
- 3: No parity: data format <8-N-1>

This parameter must be consistent with the host computer, otherwise it will not be able to communicate

Function Code	Parameter Name	Setting Range	Minimum Unit	Default	Property
PC.02	Local address	0~247	1	0	○

When the local address is set to 0, it is the broadcast address, and the host computer broadcast function is realized.

The local address is unique (except for the broadcast address), which is the basis for the point-to-point communication between the host computer and the inverter.

Function Code	Parameter Name	Setting Range	Minimum Unit	Default	Property
PC.03	MODBUS response delay	0~20ms	1ms	2ms	○

Response delay: refers to the interval between the end of the inverter data reception and the transmission of data to the host computer. If the response delay is less than the system

processing time, the response delay is based on the system processing time. If the response delay is longer than the system processing time, the system waits until the response delay time arrives before the system processes the data. send data.

Function Code	Parameter Name	Setting Range	Minimum Unit	Default	Property
PC.04	Serial communication timeout	0.0s~60.0s	0.1s	0.0s	○

When the function code is set to 0.0 s, the communication timeout time parameter is invalid.

When the function code is set to a valid value, if the interval between one communication and the next communication exceeds the communication timeout period, the system will report a communication failure error (E-15). Normally, it is set to be invalid. If you set the secondary parameters in a continuous communication system, you can monitor the communication status.

Function Code	Parameter Name	Setting Range	Minimum Unit	Default	Property
PC.05	MODBUS communication data format	0~1	1	0	○

**0: Non-standard MODBUS protocol**

**1: Standard MODBUS protocol**

Function Code	Parameter Name	Setting Range	Minimum Unit	Default	Property
PC.06	Communication reading current resolution	0~1	1	0	○

**0: 0.01A**

**1: 0.1A**

